

ASCENDING TOGETHER

Elevator

ALOMEX

Ascending Together

www.alamex.com.tr



HOME LIFT | 2024

PRODUCT CATALOGUE

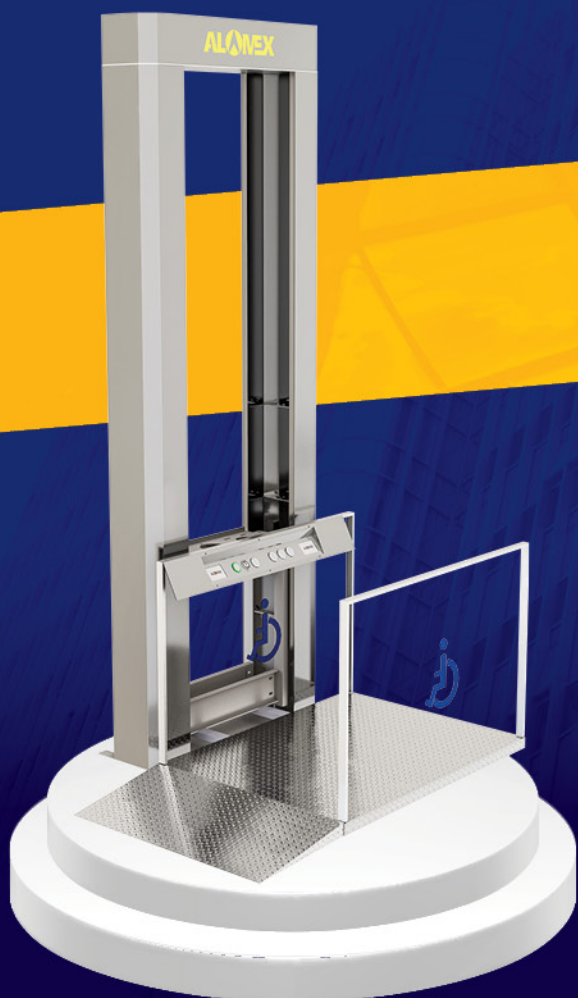

THE ELLIES 2022

Best Supplier – Parts
Headquarters: Bloomfield,
Connecticut
Runner up: Alamex
Headquarters: Mexico City



ABOUT ALAMEX

We are a young and dynamic company, we began operations in Latin America in 2011, with more than 20 years of experience. At Alamex, we design top-quality lifting solutions with cutting-edge innovations.

Alamex is a company specialized in designing, developing, manufacturing, distributing, installing, and maintaining high-tech lifting solutions. We produce all types of elevator systems including passenger elevators, home elevators, platform elevators, dumbwaiters, construction elevators, cargo elevators, and more.

We have exports to more than 55 countries in Europe, North America, South America, Africa, Asia & Australia.

All our products are manufactured in accordance with the latest European Standards for Safety and Quality, which guarantees high durability with minimal maintenance.



Elevator Systems

- Passenger Elevator
- Home Elevator
- Platform Elevator
- Service Elevator (Dumbwaiter)
- Cargo Elevator



Parking Systems

- Car Lift Platform
- Car Stack
- Automated Parking Systems



Escalators & Moving Walkways

- Escalators
- Moving Walkways



20
YEARS
OF EXPERIENCE

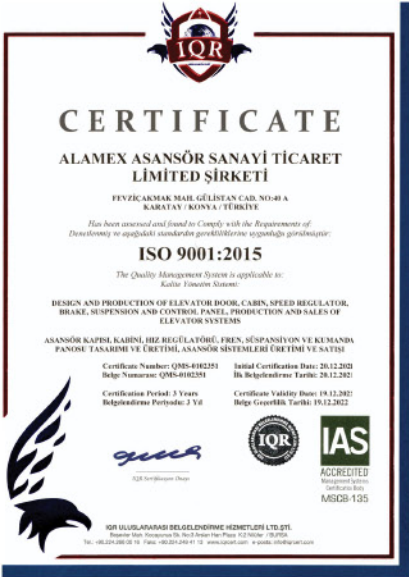

ALAMEX ISO

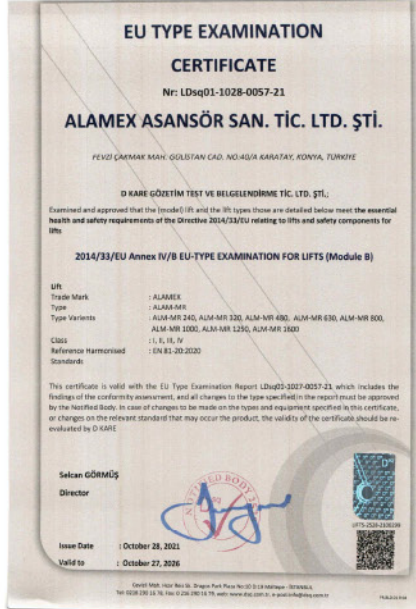

ALAMEX MR

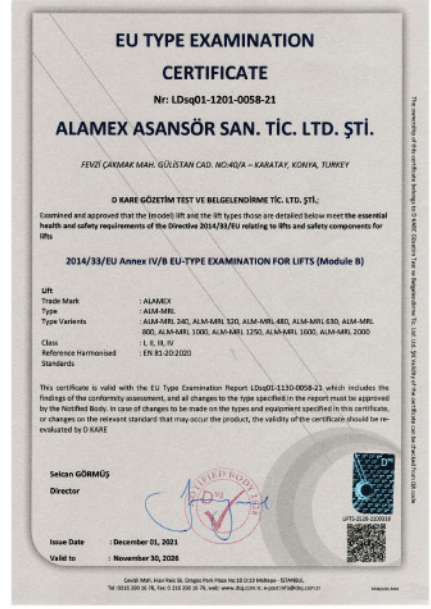

ALAMEX MRL



OVERSPEED GOVERNOR



SAFETY GEAR

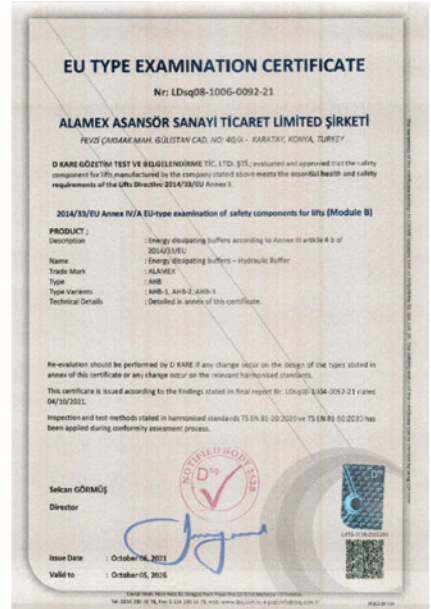

HYDRAULIC BUFFER



Devices For Locking Cabin Doors



WHY CHOOSE US



Lifting solutions from conceptualization and design to specify the installation and maintenance.



National and international certifications of compliance with the latest safety and quality standart.



Customer support in 6 languages





INTERNATIONAL PRESENCE



Thanks to our professional team, we could improve our product quality and develop new technologies to the extend that we became internationally well-known for our unique products and services.

Our exports extends internationally, currently to more than 55 countries in 5 continents around the world.

We also provide customer support in 6 languages.



<ul style="list-style-type: none"> Barbados Canada Costa Rica Guatemala Mexico Netherlands Panama The Salvador USA 	<ul style="list-style-type: none"> Colombia Paraguay 	<ul style="list-style-type: none"> Algeria Egypt Ethiopia Kenya Libya Mauritania Morocco Mozambique Tunisia Zanzibar 	<ul style="list-style-type: none"> Belarus Danimark Greece Georgia Italy Romania Slovakia Ukraine 	<ul style="list-style-type: none"> Armenia Bahrain Dubai Azerbaijan Iraq Jordan Kazakhstan Kuwait Lebanon Oman Palestine Philippines Russia Qatar Saudi Arabia Syria Turkmenistan UAE 	<ul style="list-style-type: none"> Australia
---	--	--	---	---	---

Elevator

ALOMEX

Ascending Together

HOME
LIFT



ASCENDING
TOGETHER

HYDRAULIC ELEVATOR PLATFORM ELEVATOR

At Alamex we present a new lifting solution for limited spaces, where the dimensions of some architectural space are not possible to place a conventional elevator, giving rise to the flexibility and easy installation of a home lift.

The great advantages of the home lift is that it optimizes the available spaces in new or existing buildings, having minimal electrical consumption, an avant-garde design and easy installation.



Minimum requirements in bucket depth and machine room.



Capacity from 200 to 5,000 Kg.



Maximum speed of 0.6 m / s



Manufactured in accordance with machinery directive 2006/42 / EC and EN-81.



Pre-assembled in rigid steel structure.



Available with platform, half cab, or full cab



DUPLEX VILLAS ELEVATOR



Easy and trouble-free installation in any area as it does not require a pit

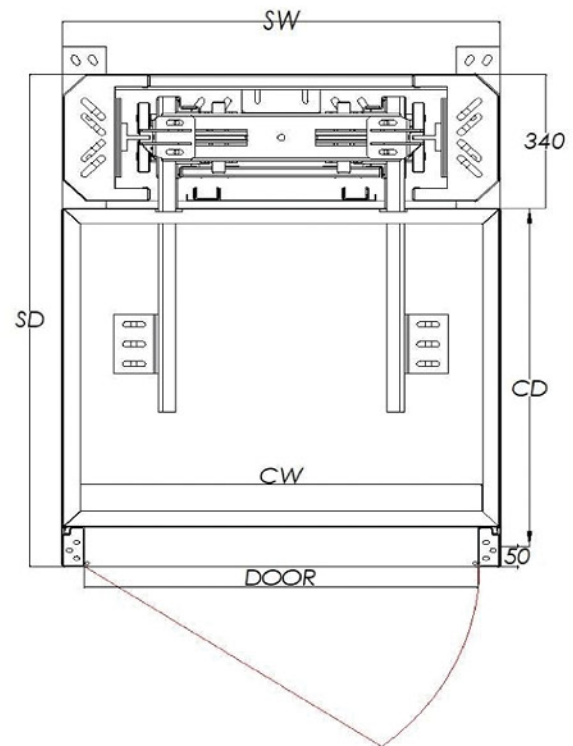

DOOR	SD	SW	PD	PW	N. OF PERSONS	CAPACITY
600 mm	990 mm	700 mm	600 mm	600 mm	1 Persons	150 kg
650 mm	1040 mm	750 mm	650 mm	650 mm	2 Persons	180 kg
700 mm	1090 mm	800 mm	700 mm	700 mm	2 Persons	220 kg
750 mm	1140 mm	850 mm	750 mm	750 mm	3 Persons	250 kg
800 mm	1190 mm	900 mm	800 mm	800 mm	3 Persons	300 kg
850 mm	1240 mm	950 mm	850 mm	850 mm	4 Persons	300 kg
900 mm	1290 mm	1000 mm	900 mm	900 mm	4 Persons	400 kg



TECHNICAL SPECIFICATIONS

DUPLEX VILLAS ELEVATOR

NUMBER OF STOPS	2 to 5.
TRAVEL DISTANCE	Maximum 15 meters (Max).
DRIVE SYSTEM	Hydraulic, Screw Column
MAXIMUM LOAD CAPACITY	Up to 400 kilograms.
TRAVEL SPEED	0.15 m/s.
PAINT	Options of Stainless Steel or specified color (RAL).
SAFETY EQUIPMENT	Parachute Brake.
DOOR	Glass, Painted RAL, Automatic or Manual
PIT DEPTH	Minimum 50 mm.
INTERCOM	Communication System.
Announcement System.	With Desired Language Option
EMERGENCY RESCUE SYSTEM	Backup system (UPS) for rescue, Manual Valve.
POWER OPTIONS	220-230 volts (Single Phase), 380-400 volts (Three Phase).



DUPLEX VILLAS ELEVATOR



ELEVATOR STRUCTURE COLOR

- RAL 7012
- RAL 7016
- RAL 7032
- RAL 7035
- RAL 9005
- RAL 9016

GLASS CLADDING COLOR OPTIONS

- Transparent Glass
- Blue Glass
- Fume Glass
- Bronze Glass

ELEVATOR STRUCTURE TYPE

RAL Paint

- RAL 9006
- RAL 7032
- RAL 7035
- RAL 5005
- RAL 7040
- RAL 7033
- RAL 7034
- RAL 7035

DOOR TYPE

- Swing Automated Door
- Telescopic Door
- Manual Door



EXPLANATION

- It is a compact product
- Does not require significant structural changes in the location where it will be installed
- Your Home, Office etc. It can be installed anywhere.
- Thanks to sensitive sensors on the cabin floor and ceiling, it does not cause any narrowing in space
- When there is a power cut, it will automatically go down to the ground floor with the UPS system
- Voice announcement system notifies cabin movement



ENCLOSED TYPE PLATFORM (DISABLED) PLATFORM



Easy and trouble-free installation in any area as it does not require a pit

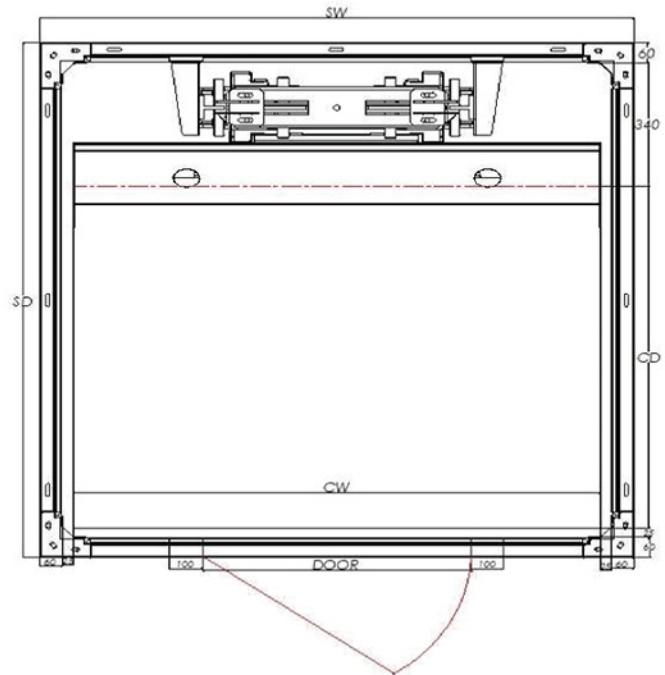

DOOR	SD	SW	PD	PW	N. OF PERSONS	CAPACITY
600 mm	1290 mm	970 mm	800 mm	800 mm	3 Persons	225 kg
700 mm	1390 mm	1070 mm	900 mm	900 mm	4 Persons	320 kg
800 mm	1490 mm	1170 mm	1000 mm	1000 mm	5 Persons	375 kg
900 mm	1590 mm	1270 mm	1100 mm	1100 mm	6 Persons	450 kg



TECHNICAL SPECIFICATIONS

DUPLEX VILLAS ELEVATOR





NUMBER OF STOPS	2 to 5 stops
TRAVEL DISTANCE	Maximum 15 meters.
TRACTION SYSTEM	Hydraulic, Screw
LOAD CAPACITY	Up to 500 kg
SPEED	0.15-0.30 m/s
COATING	Stainless steel/RAL colors option
SAFETY EQUIPMENT	Parachute Brake.
DOOR	Glass, RAL painted, semi-automatic, fully automatic
PIT DEPTH	Minimum 50 mm.
INTERCOM	Communication System.
VOICE ANNOUNCEMENT SYSTEM	With the option to select desired language, EMERGENCY RESCUE UPS System, Manual Valve.
EMERGENCY RESCUE SYSTEM	Backup system (UPS) for rescue, Manual Valve.
POWER OPTION	SINGLE PHASE 220-230 V THREE PHASE 380-400 V



ENCLOSED TYPE PLATFORM (DISABLED) PLATFORM

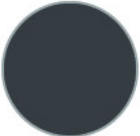









ELEVATOR STRUCTURE COLOR





-  RAL 7012
-  RAL 7016
-  RAL 7032
-  RAL 7035
-  RAL 9005
-  RAL 9016

ELEVATOR STRUCTURE TYPE

RAL Paint

-  RAL 9006
-  RAL 7032
-  RAL 7035
-  RAL 5005
-  RAL 7040
-  RAL 7033
-  RAL 7034
-  RAL 7035

GLASS COLOR OPTIONS

-  Transparent Glass
-  Blue Glass
-  Fume Glass
-  Bronze Glass

DOOR TYPE

- Swing Automated Door
- Telescopic Door
- Manual Door



EXPLANATION

- It has a wide place.
- It is produced in compliance with the regulations of 2006/42/AT and it is introduced into the market with CE mark.
- The traction system can be implemented using hydraulic technology or endless screw technology.
- It can be used safely indoors and outdoors.
- Thanks to not requiring a pit, it can be easily and smoothly installed in any area.
- No major structural changes are needed.
- It can be used in both open and closed spaces.
- It offers options for automatic and semi-automatic doors.



OPEN TYPE
DISABLED PLATFORM



User and environmental safety is kept at the highest Level

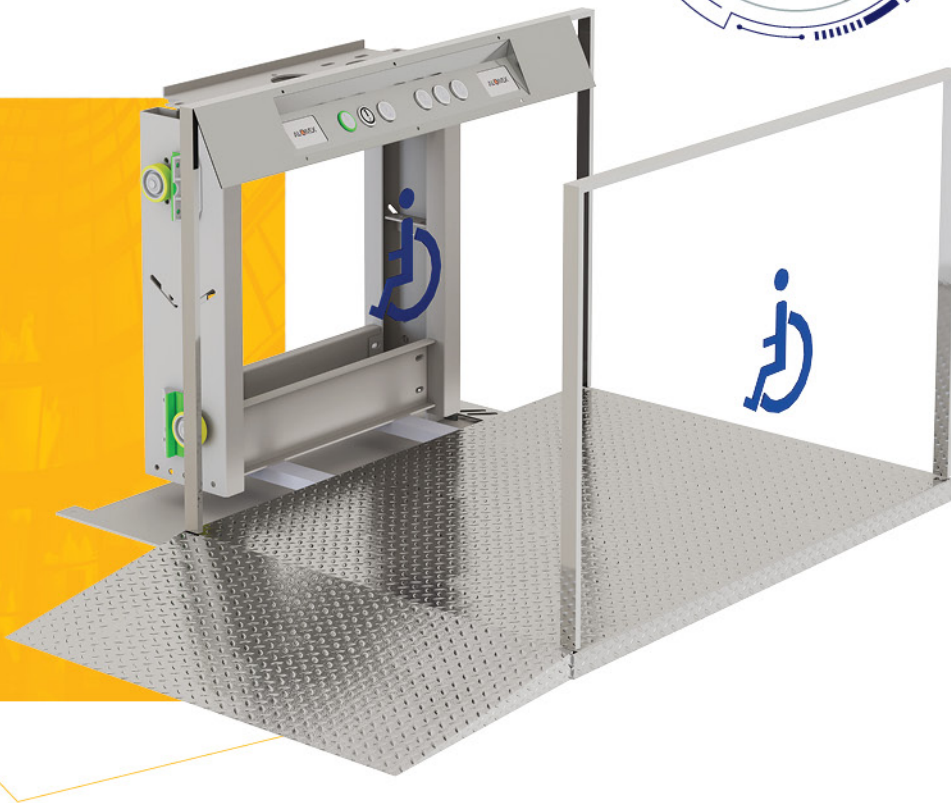
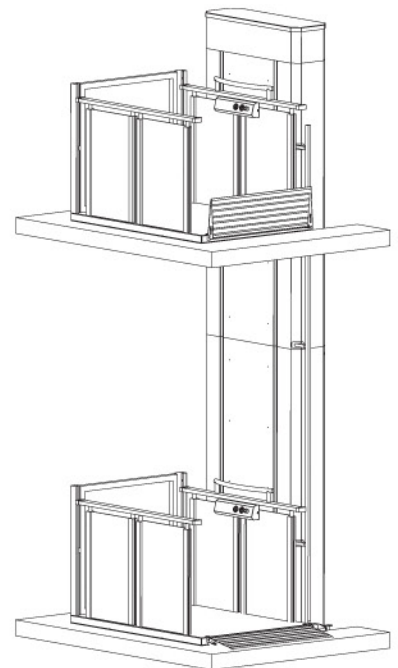
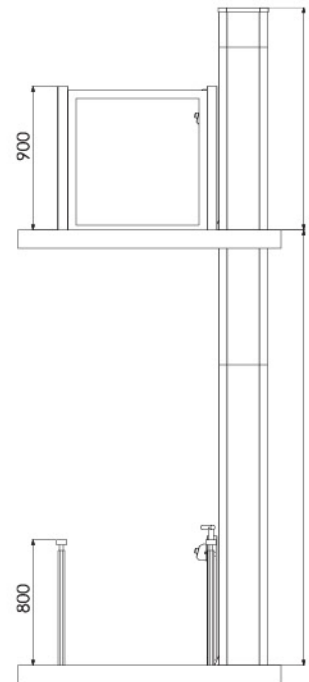

EXPLANATION

- It is a stylish model with double-sided carrier columns and attaches great importance to security.
- It can be used safely indoors and outdoors.
- Its outer coating consists of stainless material.
- Does not require a shaft.





TECHNICAL SPECIFICATIONS

DOOR	SD	SW	PD	PW	CAPACITY
800 mm	1200 mm	1290 mm	1200 mm	800 mm	300 kg
850 mm	1200 mm	1340 mm	1250 mm	850 mm	300 kg
900 mm	1400 mm	1540 mm	1300 mm	900 mm	300 kg

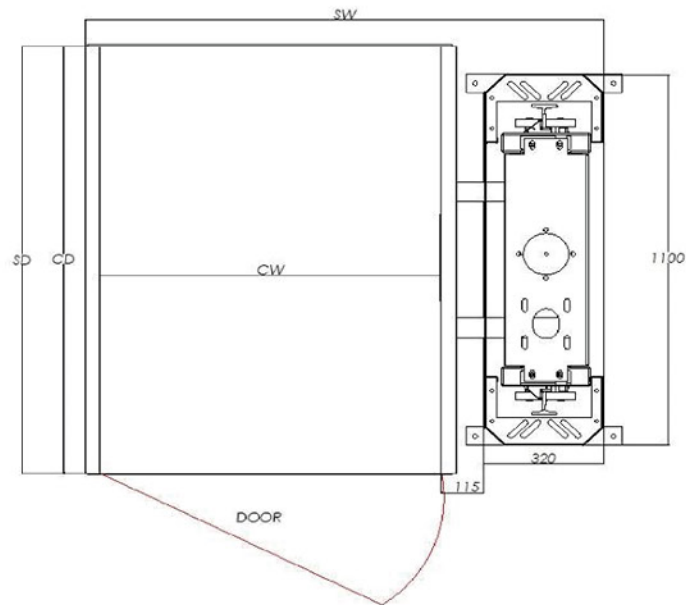

OPEN TYPE
DISABLED PLATFORM



**ELEVATOR
STRUCTURE COLOR**

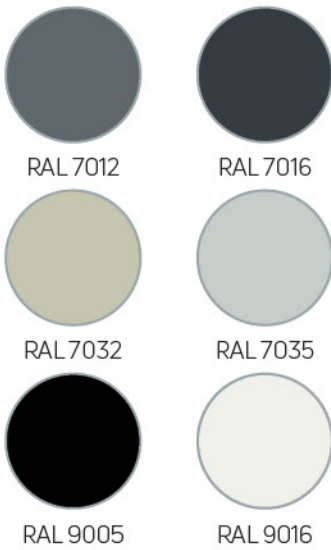

**GLASS COLOR
OPTIONS**

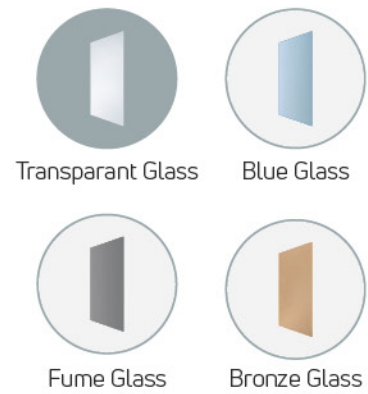

**ELEVATOR
STRUCTURE TYPE**

RAL Paint

**DOOR
TYPE**

- Swing Automated Door
- Telescopic Door
- Manual Door

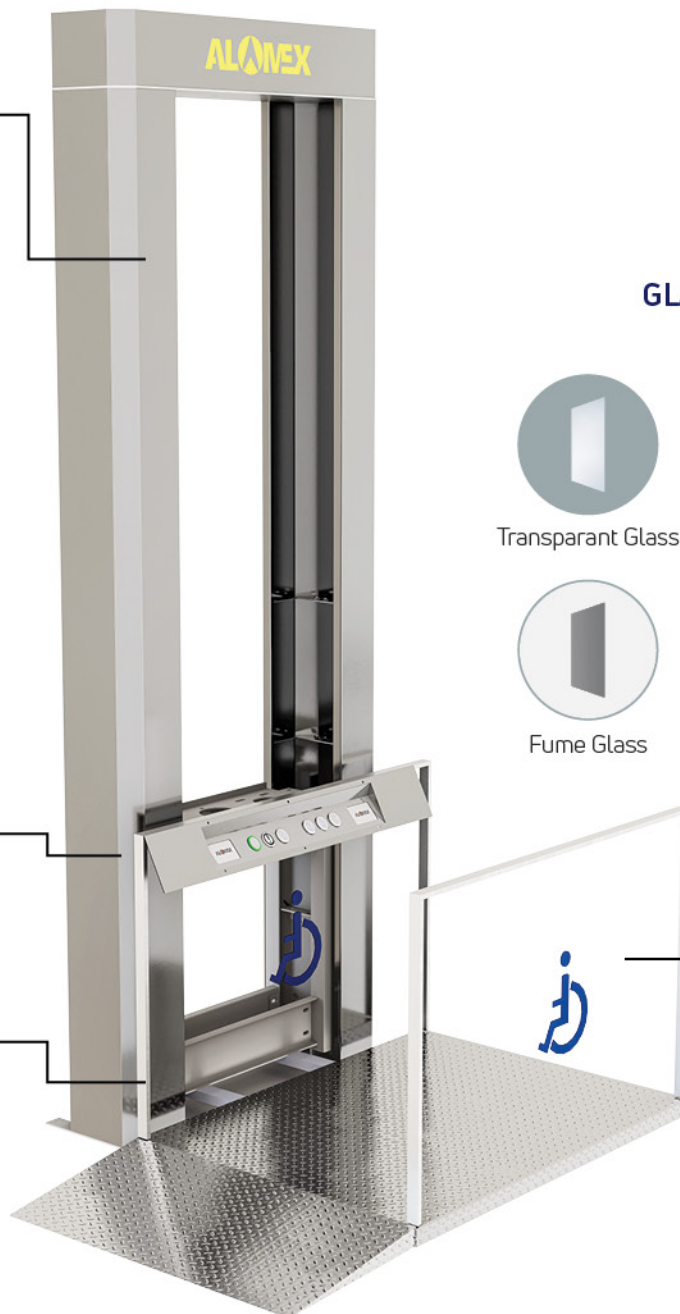

TRACTION ELEVATOR **SERVICE ELEVATOR**

It is a small service traction elevator with or without a machine room for small capacities.
It is suitable for service jobs such as libraries, restaurants, hotels, department stores or residential.

SERVICE ELEVATOR GUILLOTINE DOOR

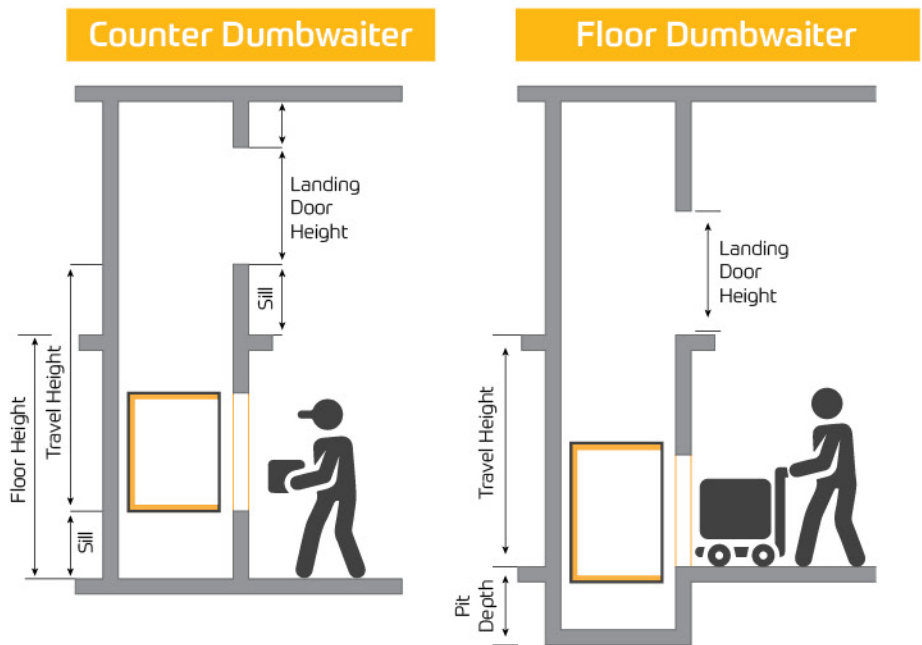

Manufactured in accordance with the machinery directive 2006/42 / EC and EN-81.



Capacity from 100 to 300 Kg.



Travel up to 30 meters (10-15 stops approximately).
Capacity: 300 Kg.



Smooth and quiet operation.
Quick and easy installation.



Minimum machine room space.
No need for a pit.

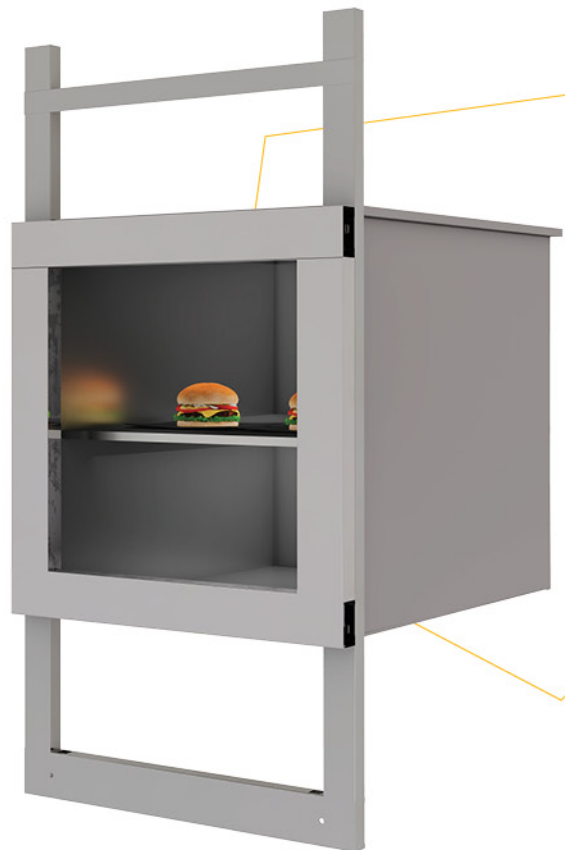

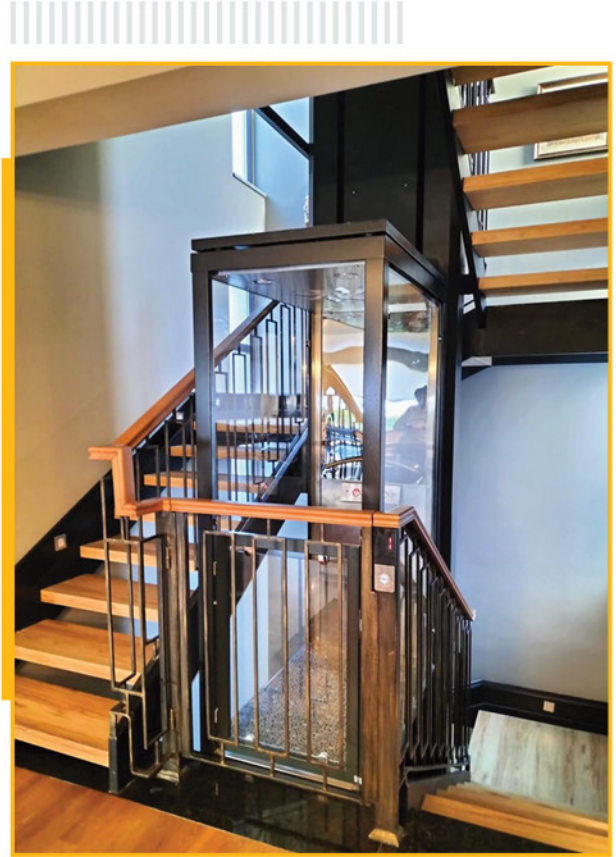

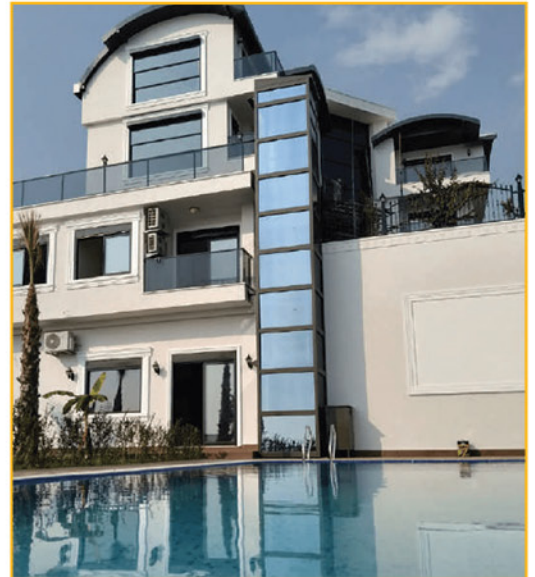

Elevator systems
> we export to the World



ING SYSTEMS PROBOTIC PARKING SYS
ELEVATOR SYSTEMS
TECHNOLOGY ESCALATOR MOVING WALKWAYS TOUCHLESS TECHN
DOORS SPARE PARTS ACCESSORIES CABINS DOORS SPARE PARTS ACCESSO

20 YEARS

of experience

SYSTEMS ELEVATOR SYSTEMS PROBOTIC
TECHNOLOGY ESCALATOR MOVING WALKWAYS TOU
ACCESSORIES CABINS DOORS SPARE PARTS

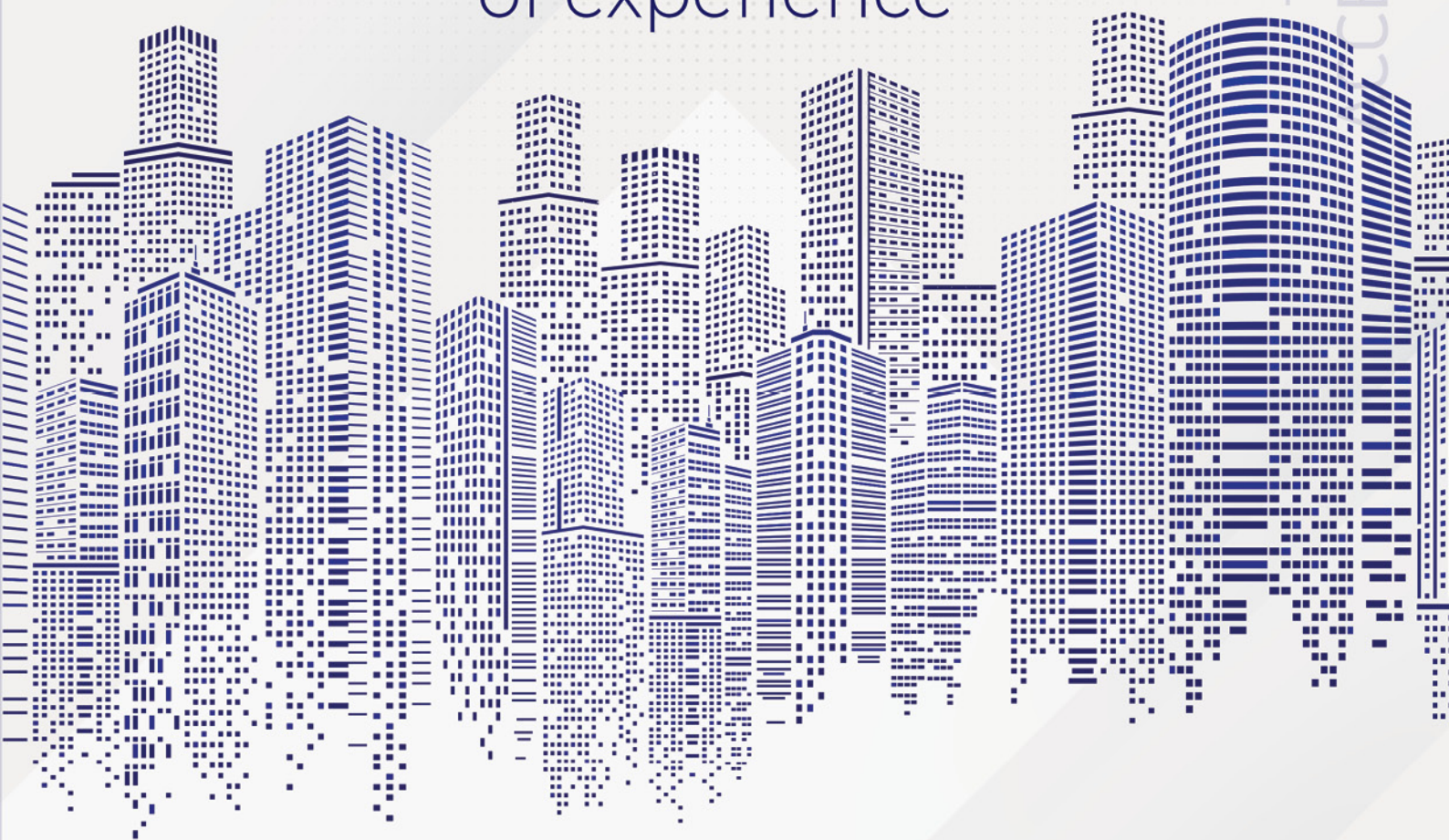

Elevator

ALAMEX
Ascending Together

ASCENDING
TOGETHER



ALAMEX ELEVADORES

- 219 Av. Tlahuac
CDMX CMX 09840 México
- +52 55 5532 2739
- +52 55 1952 18 57
- sales@alam.mx
- www.alam.mx



ALAMEX ELEVATOR

- Fevzi Çakmak Mah. İmsan Sanayi Sit.
Gülistan Cad. No:40/1 - 42050 Karatay/KONYA
- +90 (332)503 15 08
- 0090 0535 975 68 66
- info@alamex.com.tr
- www.alamex.com.tr

