



**ÜRÜN
KATALOĞU**
Product Catalogue



www.alamex.com.tr

Elevators

ALAMEX®

Ascending Together

İçindekiler | Contents

01	Hakkımızda About Us	04-05
02	Kabinler Cabins	08-23
03	Panoramik Kabin & Hastane ve Yük Kabini Panoramic Cabins & Hospital & Freight Cabin	24-25
04	Araç Asansörü & Servis Asansörü Vehicle Elevator & Dumbwaiter Elevator	26-27
05	Engelli Platformu & Yürüyen Merdivenler Platform For Disabled People & Escalator	28-29
06	Makine Motor Seçenekleri Machine Motor Options	30-31
07	Buton Button	32-33
08	Kat Kapıları Landing Door	34
09	Otomatik Kapı Automatic Doors	35-37
10	Dekoratif Paslanmaz & Süspansiyonlar Decostyle Stainless & Suspensions	38-39
11	Kumanda Panoları Control Panels	40-41
12	Asansör Ekipmanları Elevator Equipments	42-43
13	Tavan Seçenekleri & Taban Seçenekleri Ceiling Options & Floor Options	44-45
14	Cam Kaplama Laminated Glass	46-47

Yüksek teknolojili kaldırma sistemlerinin tasarımı, geliştirilmesi, üretimi ve dağıtımında uzman kuruluş.



Kalitede Üstün Performans
 Superior Performance in Quality

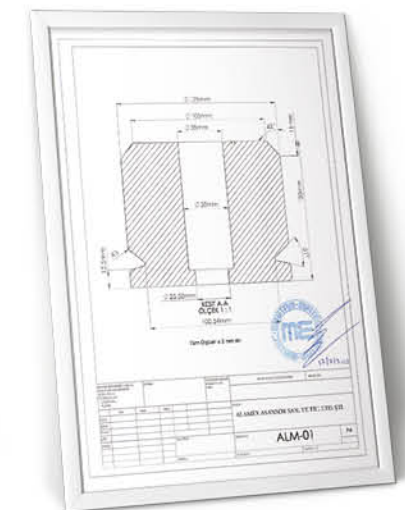

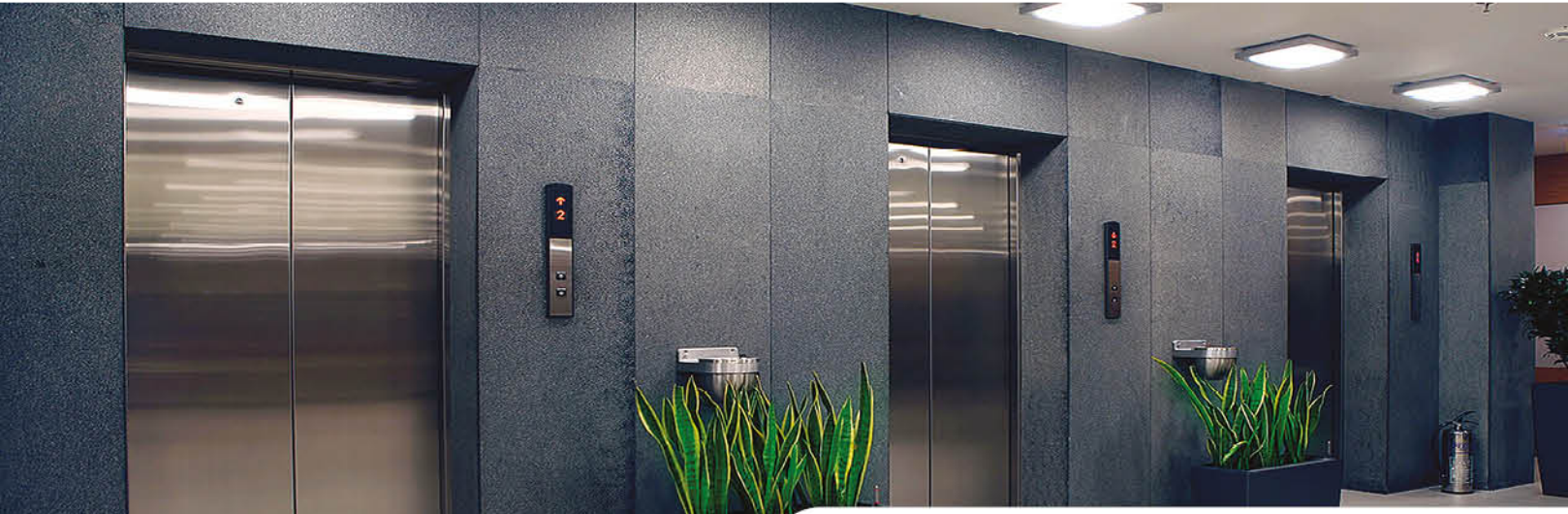

ALAMEX HAKKINDA

Alamex; yüksek teknolojili kaldırma sistemlerinin tasarımı, geliştirilmesi, üretimi ve dağıtımında uzmanlaşmış bir şirkettir.

Alamex; asansörler, yürüyen merdivenler, yürüyen bantlar ve otopark sistemleri üreterek bunları dünya çapında çoğu ülkedeki ortaklarına ihraç etmektedir.

Kalite Politikası

Farklı asansör türlerinin tasarımını, kurulumunu, modernizasyonunu, bakımını ve nakliye süreçlerinin profesyonel bir şekilde gerçekleştirilmesine özen göstererek, Avrupa, Asya, Afrika ve Güney Amerika kıtalarında inşaat piyasasına önemli katkılarda bulunmaktayız. Yenilikçi çözümler arayışı, nitelikli insan desteği ve son teknoloji ürünü tedarik zincirimizdeki süreçlerin profesyonel bir şekilde yönetilmesiyle en yüksek kalitede ve güvenli ürünler sunmaktayız. Modern teknolojileri takip edip yasal yönetmeliklere uyarak, müşterilerimizin memnuniyetini sağlamaktayız.

Vizyonumuz

Uzun yıllardır sektörde edindiği deneyim ve bilgi birikimi ile hareket eden firmamız; müşterilerimizin kalite ve hizmet beklentileri için sürekli ilerleyerek yenilikçi bir lider olmak ve pazar payımızı artırmaktır.

Müşteriye her aşamada daha fazlasını vaat eden, iç ve dış piyasada saygın ve yenilikçi bir lider firma olmayı hedeflemektedir. Müşterilerimizin kalite ve hizmet beklentilerini sürekli olarak aşmak, yenilikçi ve lider olmak ve pazar payımızı artırmak

Felsefemiz

Ortaklarımızla uzun vadeli iş birlikliklerimizi geliştirmek ve sürdürmek önceliklerimiz arasında yer almaktadır. Yüksek kaliteyi hedefleyerek, en iyi ürün ve hizmetleri sunmaktayız. Sektörün uluslararası etkinliklerinde aktif olarak rol oynamaktayız. Her zaman bir adım önde olmayı hedefleyerek ürün kalitemizi en yüksek seviyeye getirip en talepkâr müşteriyi bile memnun etmek yükümlülüğümüzdür.

Misyonumuz

İşbirliklerimizin gelişimini ve hissedarlarımızın büyümesini teşvik ederek, yüksek kaliteli ve güvenli ürünler geliştirerek müşterilerimize en iyi nakliye deneyimini sunmak için varız.

Kalite Hedefi

Müşteri ve kullanıcılara en iyi deneyimi sağlayan yüksek kalitede ürün ve hizmetler sunmak. Müşteri memnuniyetini sağlamak. Ürünlerin verimliliğini artırmak.

Konya/Türkiye'de bir üretim tesisimiz ile beraber Mexico City'de bulunan ve devasa depolama kapasitesine sahip merkezimiz ile Latin Amerika, Kanada ve Amerika Birleşik Devletleri'nde yedek parça satışı, kurulumunda büyük çaplı bir büyüme sağlamak için gerekli unsurlara sahibiz. Genel olarak asansörlerin, yürüyen merdivenlerin, park sistemlerinin ve kaldırma mekanizmalarının modernizasyonu ve bakımı üzerine üretim yapmaktayız. Başarı ve liderlik yollarını her gün izleyerek her geçen gün geliştirdiğimiz, süreçleri içeride ve dışarıda optimize eden ilk dünya yönetim sistemlerine sahibiz. Asansör dünyasında lider olma potansiyeli bizim için bir gerçekliktir. Bu nedenle personelimizin gelişimine, müşteri hizmetlerine ve inşaat şirketleri veya diğer kuruluşlarla özel veya kamu projelerine katılacak stratejik ittifaklara; özetle toplumun gelişimine katkı sağlayabilecek her şeye büyük önem veriyoruz.

Avantajlar

Araştırma ve geliştirmede uzmanlık, Doğrudan ortaklar ve distribütörlere sürekli danışmanlık hizmetleri, Sürekli ve koordineli müşteri hizmetleri için entegre CRM sistemleri, Ürünlerin kurulumu ve bakımı için 24 saat teknik destek, Uluslararası pazardaki beceriler, alternatif ihtiyaç ve beklentilere yönelik bakım ve yenilik, Tasarımdan üretimin sonuna kadar profesyonel çözüm, Özelleştirme: Müşterinin isteğine göre tasarım ve üretim.

Neden Bizi Seçmelisiniz?

Araştırma ve geliştirmede uzmanlık, Doğrudan ortaklar ve distribütörlere sürekli danışmanlık hizmetleri, Sürekli ve koordineli müşteri hizmetleri için entegre CRM sistemleri, Ürünlerin kurulumu ve bakımı için 24 saat teknik destek, Uluslararası pazardaki beceriler, alternatif ihtiyaç ve beklentilere yönelik bakım ve yenilik, Tasarımdan üretimin sonuna kadar profesyonel çözüm, Özelleştirme: Müşterinin isteğine göre tasarım ve üretim.



ALAMEX ABOUT

Alamex is a company specialized in designing, developing, manufacturing, distributing of high-tech lifting solutions. Alamex produces elevators, escalators, moving walkways and parking systems, exporting them to its partners in more than 55 countries around the world.

Quality Policy

At Alamex we are committed to the design, installation, modernization, repair and maintenance of elevating devices, as well as the commercialization of spare parts for them, offering immediate value to the leaders of the real estate market and generating the best vertical transportation experience for the society of the European, Asian, and African continents. It is imperative for us to offer products and services of the highest quality and safety through the management of processes throughout our supply chain in a transparent and responsible manner, with the search for innovative solutions, qualified human support, state-of-the-art technology, and compliance with the applicable regulatory requirements; we are confident that continuous improvement in our processes is the way to guarantee the satisfaction of our clients.

Vision

Continuously exceed the quality and service requirements of our clients, be disruptive, and increase our market share.

Philosophy

It is the treat we maintain with our partners to develop and maintain long-term collaborations. Dedicated to excellence in quality, we give our daily struggle to provide the best products and services. We actively participate in the international events of the industry. We are always one step ahead, innovating continuously. We are obliged to satisfy the most demanding customer.

Quality Objectives

Provide products and services of the best quality, which allow the client and users to have the best vertical transport experience. Increase the satisfaction of our customers, Improve the efficiency of resource use, Cultivate and preserve a culture of excellence and humanity within the organization.

Mission

We exist to deliver the best vertical transportation experience to our clients through products and developments of high quality and safety, promoting the development of our collaborators and the growth of our shareholders.

With a manufacturing plant in Konya, Turkey, our headquarters located in Mexico City and having massive storage capacity, we have the necessary elements to achieve a large-scale expansion in Latin America, Canada and the United States in the sale of spare parts, installation, modernization and maintenance of elevators, escalators, parking systems and lifting mechanisms in general. We have first world management systems that we improve day by day taking the paths of success and leadership always present, optimizing processes internally and externally. The potential to be leaders in the world of elevators is a reality for us, that is why we attach great importance to the development of our personnel, customer service and strategic alliances with construction companies or other organizations to participate in private or public projects, also helping the general growth of society.

Strategic Advantages

Specialization in research and development, Continuous consulting services to direct associates and distributors, Integrated CRM systems for continuous and coordinated customer service, Technical support 24 hours for the installation and maintenance of the products, Skills in the international market, treatment and innovation for alternative needs and expectations, Integrated elevation solution, from the design to the placement, Customization: Design and manufacture according to the customer's specifications.

Why Choose Us

The first thing we analyze is your particular situation and then develop with you the solution that best suits your needs. We believe in the pursuit of excellence in everything we do supporting growth for the benefit of our customers. Because we have a commitment to quality and timely service, for the complete satisfaction of our customers and business partners.

**Kabinler
Cabins**



ALM-S 1001

ÖZELLİKLER | PROPERTIES

- TR Arka Duvar** : Tam boy ayna
Tavan : Lazer kesim paslanmaz
Taban : Lamine cam + Doğal granit
Aksesuarlar : Altın paslanmaz
Küpeşte : Krom nikel paslanmaz
Yan Duvar : Dekoratif taş döşeme

- EN Back Wall** : Full mirror
Ceiling : Laser cutting stainless
Floor : Laminate glass natural granite
Accessories : Gold Stainless
Handrail : Chrome stainless nickel
Side Wall : Decorative stone flooring

Kaplama | Coating



Doğal Taş - Natural Stone

Tavan | Ceiling



ALM-T-04

Zemin | Floor



Star Galaxy



ALM-S 1002



ALM-S 1003

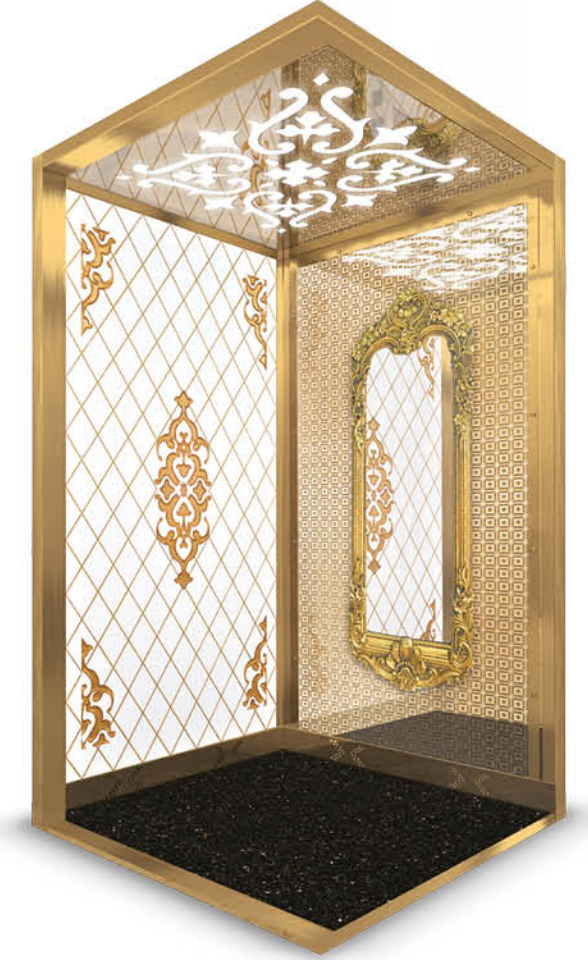

ALM-S 1004



ALM-S 1005

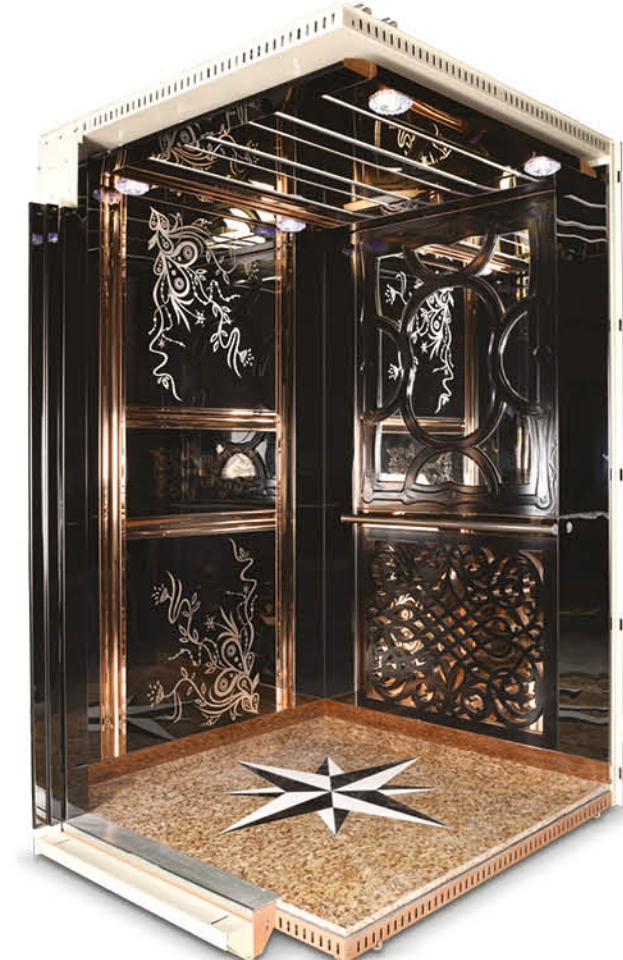

ALM-N 2001

ÖZELLİKLER | PROPERTIES

- TR Arka Duvar** : Tam boy ayna
Tavan : Lazer kesim paslanmaz
Taban : Seramik
Aksesuarlar : Altın paslanmaz
Küpeşte : Krom nikel paslanmaz
Yan Duvar : Dekoratif altın paslanmaz

- EN Back Wall** : Full mirror
Ceiling : Laser cutting stainless
Floor : Ceramic
Accessories : Gold stainless
Handrail : Chrome stainless nickel
Side Wall : Decorative gold stainless

Kaplama | Coating



ALM-T-DS-21

Tavan | Ceiling

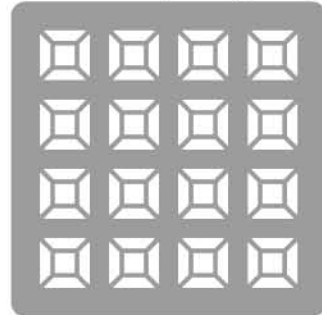

ALM-T-04

Zemin | Floor



ACT-16



ALM-N 2002

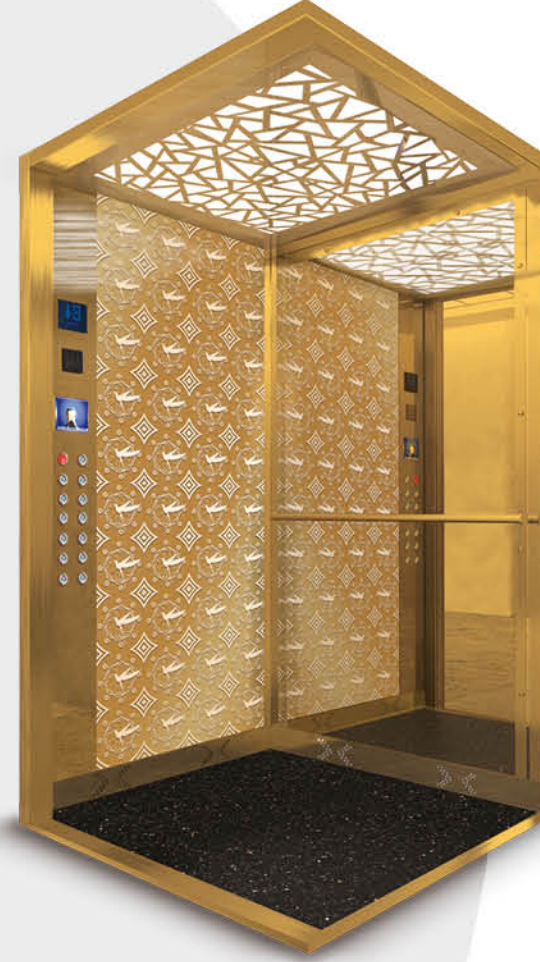

ALM-N 2004



ALM-N 2003

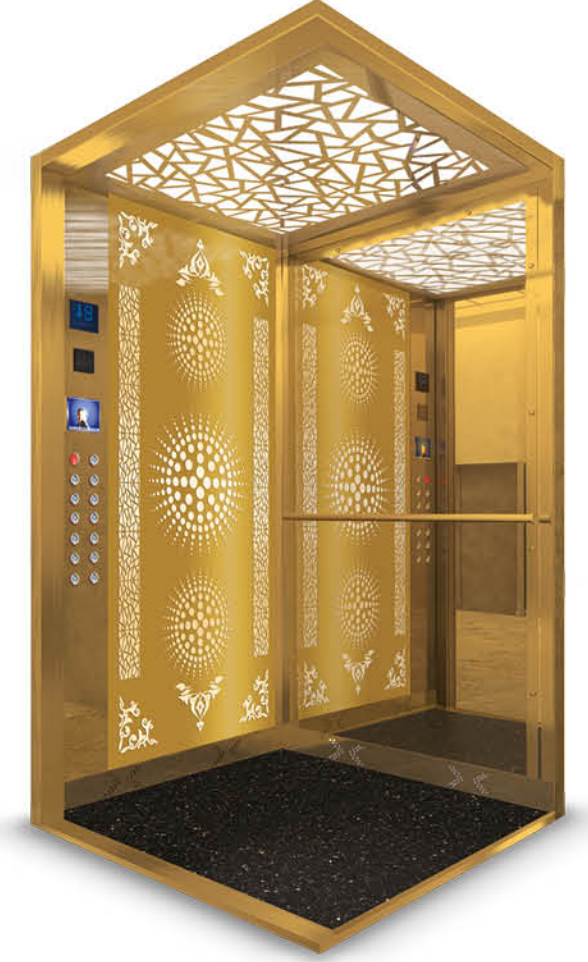

ALM-N 2005



ALM-G 3001

ÖZELLİKLER | PROPERTIES

- TR Arka Duvar** : Tam boy ayna
Tavan : Lazer kesim paslanmaz - Lamine cam
Taban : Lamine cam
Aksesuarlar : Dekoratif altın paslanmaz
Küpeşte : Krom nikel paslanmaz
Yan Duvar : Dikey döşeme laminant panel

- EN Back Wall** : full length mirror
Ceiling : Laser cut stainless - Laminate glass
Floor : Laminate glass
Accessories : Decorative gold stainless
Handrail : Chrome stainless nickel
Side Wall : Vertical floor laminate panel

Kaplama | Coating



G-3001

Tavan | Ceiling



ALM-T-26

Zemin | Floor



ACT-17

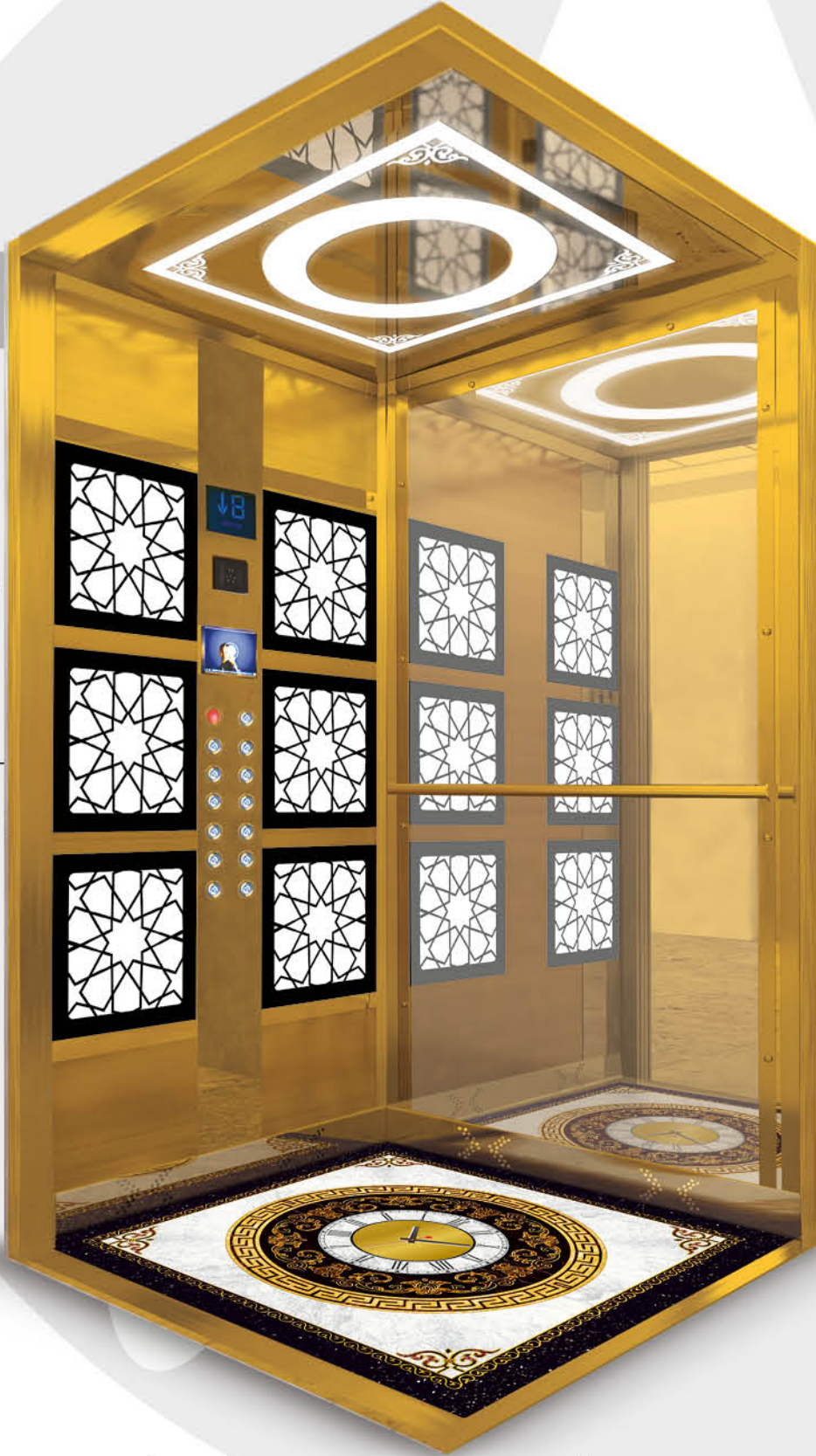

ALM-G 3002

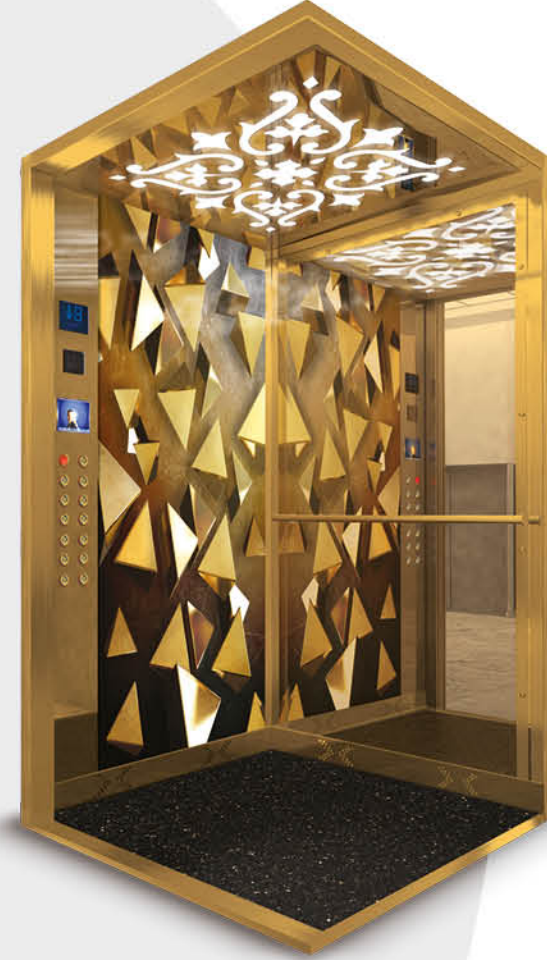

ALM-G 3004

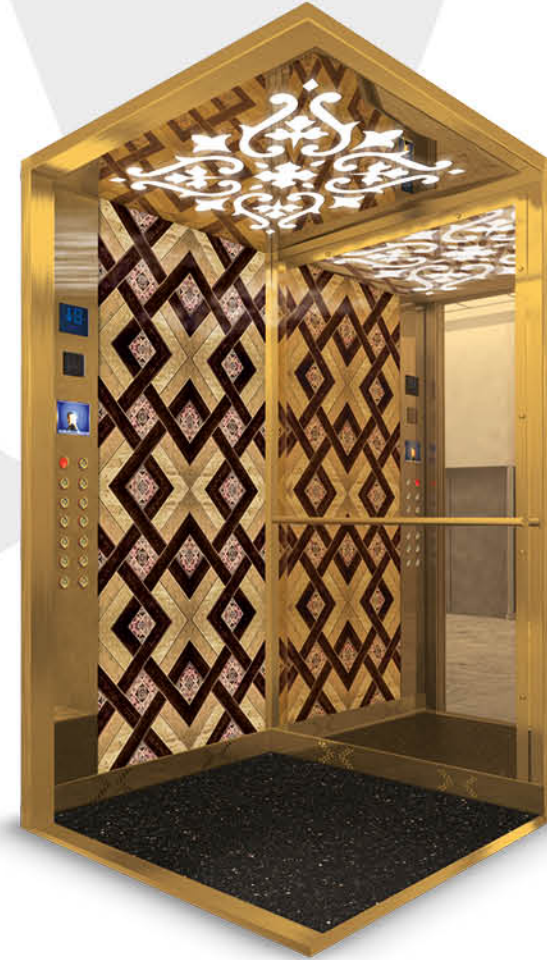

ALM-G 3003

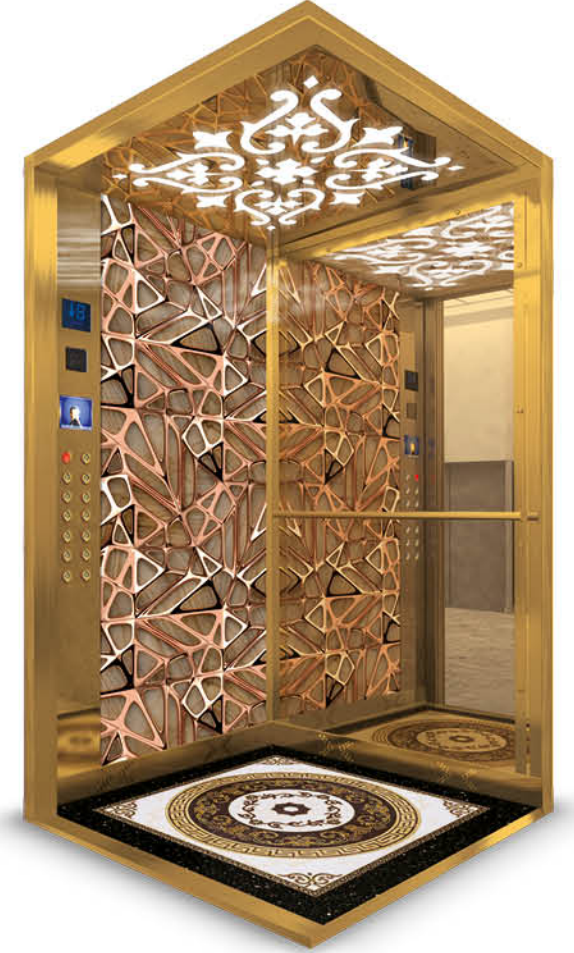

ALM-G 3005

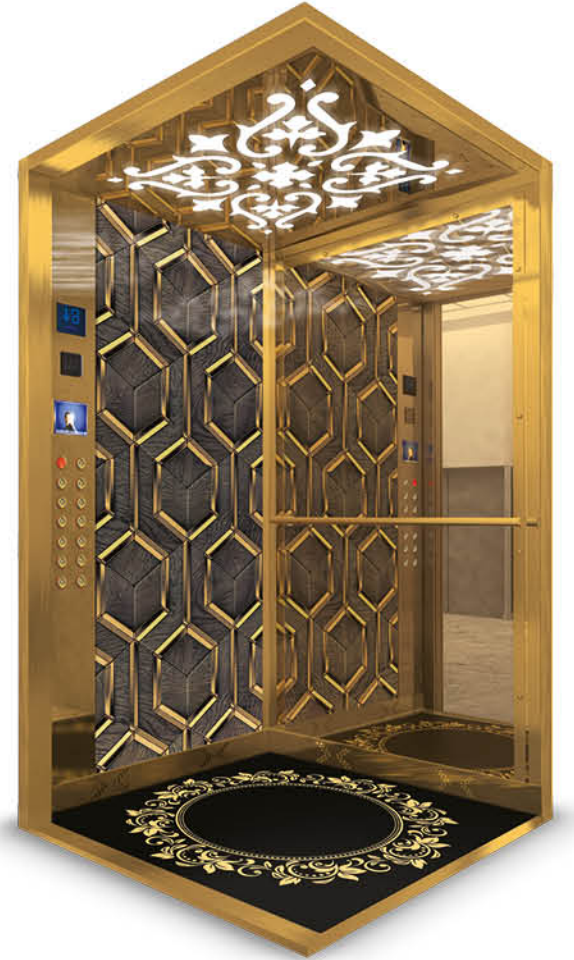

Kabinler | Cabins

ALM-G 3006

ÖZELLİKLER | PROPERTIES

- TR Arka Duvar** : Tam boy ayna
Tavan : Lazer kesim paslanmaz
Taban : Lamine cam
Aksesuarlar : Altın Paslanmaz
Küpeşte : Krom nikel paslanmaz
Yan Duvar : Lamine cam

- EN Back Wall** : Full mirror
Ceiling : Laser cutting stainless
Floor : Laminate glass
Accessories : Gold stainless
Handrail : Chrome stainless nickel
Side Wall : Laminate glass

Kaplama | Coating



G-3006

Tavan | Ceiling



ALM-T-07

Zemin | Floor



ACT-18



ALM-G 3007



ALM-G 3009



ALM-G 3008



ALM-G 3010



Kabinler | Cabins

ALM-G 3011

ÖZELLİKLER | PROPERTIES

TR Arka Duvar : Tam boy ayna
Tavan : Lazer kesim paslanmaz
Taban : Lamine cam
Aksesuarlar : Ayna paslanmaz
Küpeşte : Krom nikel paslanmaz
Yan Duvar : Lamine cam

EN Back Wall : Full mirror
Ceiling : Laser cutting stainless
Floor : Laminate glass
Accessories : Mirror stainless
Handrail : Chrome stainless nickel
Side Wall : Laminate glass

Kaplama | Coating

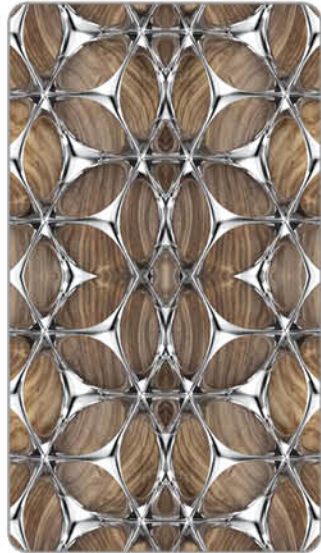

G-3011

Tavan | Ceiling



ALM-T-07

Zemin | Floor



ACT-01



ALM-G 3012



ALM-G 3014



ALM-G 3013



ALM-G 3015

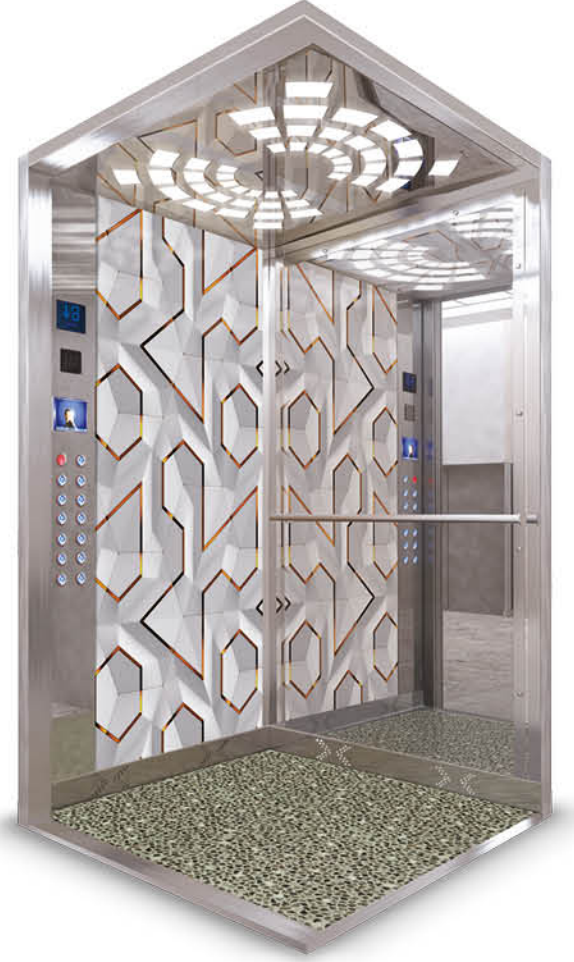

Kabinler | Cabins

ALM-G 3016

ÖZELLİKLER | PROPERTIES

TR Arka Duvar : Tam boy ayna
Tavan : Lazer kesim paslanmaz
Taban : Lamine cam
Aksesuarlar : Ayna paslanmaz
Küpeşte : Krom nikel paslanmaz
Yan Duvar : Lamine cam

EN Back Wall : Full mirror
Ceiling : Laser cutting stainless
Floor : Laminate glass
Accessories : Mirror stainless
Handrail : Chrome stainless nickel
Side Wall : Laminate glass

Kaplama | Coating



G-3016

Tavan | Ceiling



ALM-T-07

Zemin | Floor



Star Galaxy



ALM-G 3017

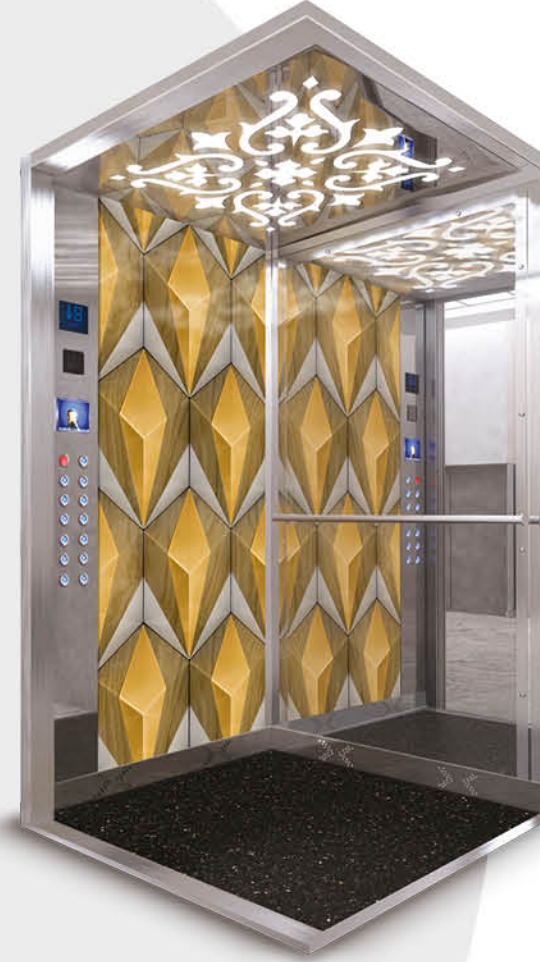

ALM-G 3019



ALM-G 3018



ALM-G 3020



ALM-G 3021

ÖZELLİKLER | PROPERTIES

- TR Arka Duvar** : Tam boy ayna
Tavan : Lazer kesim paslanmaz
Taban : Lamine cam
Aksesuarlar : Ayna paslanmaz
Küpeşte : Krom nikel paslanmaz
Yan Duvar : Lamine cam

- EN Back Wall** : Full mirror
Ceiling : Laser cutting stainless
Floor : Laminate glass
Accessories : Mirror stainless
Handrail : Chrome stainless nickel
Side Wall : Laminate glass

Kaplama | Coating



G-3021

Tavan | Ceiling



ALM-T-07

Zemin | Floor



ACT-19

ALM-G 3022



ALM-G 3024



ALM-G 3023



ALM-G 3025



Kabinler | Cabins

ALM-N 1001

ÖZELLİKLER | PROPERTIES

- TR Arka Duvar** : Tam boy ayna
Tavan : Lazer kesim paslanmaz
Taban : Doğal granit
Aksesuarlar : Ayna paslanmaz
Küpeşte : Krom nikel paslanmaz
Yan Duvar : Satine Paslanmaz

- EN Back Wall** : Full mirror
Ceiling : Laser cutting stainless
Floor : Natural granite
Accessories : Mirror stainless
Handrail : Chrome stainless nickel
Side Wall : Satine Stainless

Kaplama | Coating



ALM-T-DS-22

Tavan | Ceiling

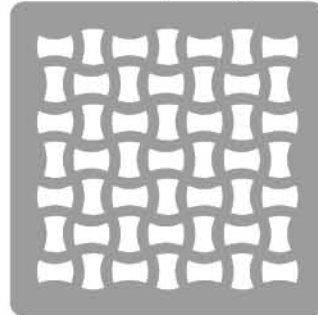

ALM-T-25

Zemin | Floor

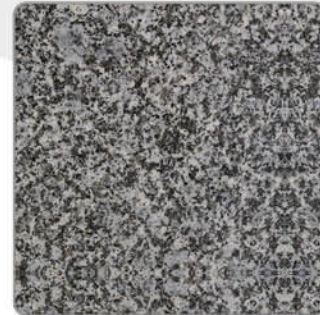

Yerli Koyu Granit



ALM-N 1002



ALM-M 1002



ALM-M 1001



ALM-M 1003



Kare Panoramik Kabin
Square Panoramic Cabin



Oval Panoramik Kabin
Round Panoramic Cabin



ÖZELLİKLER

- 1,5 mm sac kabin duvarları
- AISI304 kalite paslanmaz çelik
- Hem iç hem dış paslanmaz kaplama
- Tamamı lazer kesimli parçalar
- Kolay montaj edilebilir yapı
- Extra mukavemet için teknik bükümler
- Farklı taban ve tavan seçenekleri
- Talep doğrultusunda yapılan özel uygulamalar

PROPERTIES

- 1,5 mm sheet metal cabin wall
- AISI304 quality stainless steel
- Both internal and external stainless coating
- All parts are laser cut
- Easy assembly structure
- Technical bends for extra strength
- Different floor and ceiling options
- Special applications made on request

Hastane Kabini
Hospital Cabin



Yük Kabini
Freight Cabin



ÖZELLİKLER

- 1,5 mm sac kabin duvarları
- ESB boya seçenekleri
- Paslanmaz kaplama seçenekleri
- Çarpma yumşatıcı kuşaklar
- Tamamı lazer kesimli parçalar
- Kolay montaj edilebilir yapı
- Extra mukavemet için teknik bükümler
- Farklı taban ve tavan seçenekleri
- Talep doğrultusunda yapılan özel uygulamalar

PROPERTIES

- 1,5 mm sheet metal cabin wall
- ESB ral paint options
- Stainless coating options
- Impact softening band
- All parts are laser cut
- Easy assembly structure
- Technical bends for extra strength
- Different floor and ceiling options
- Special applications made on request

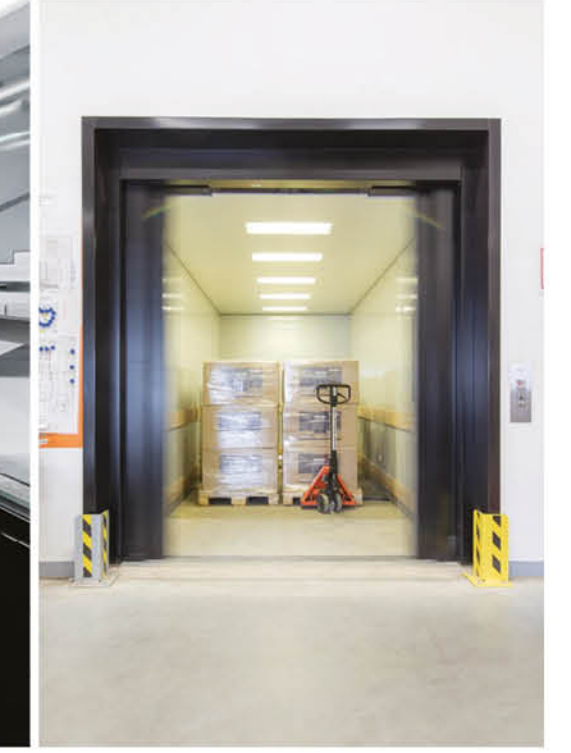
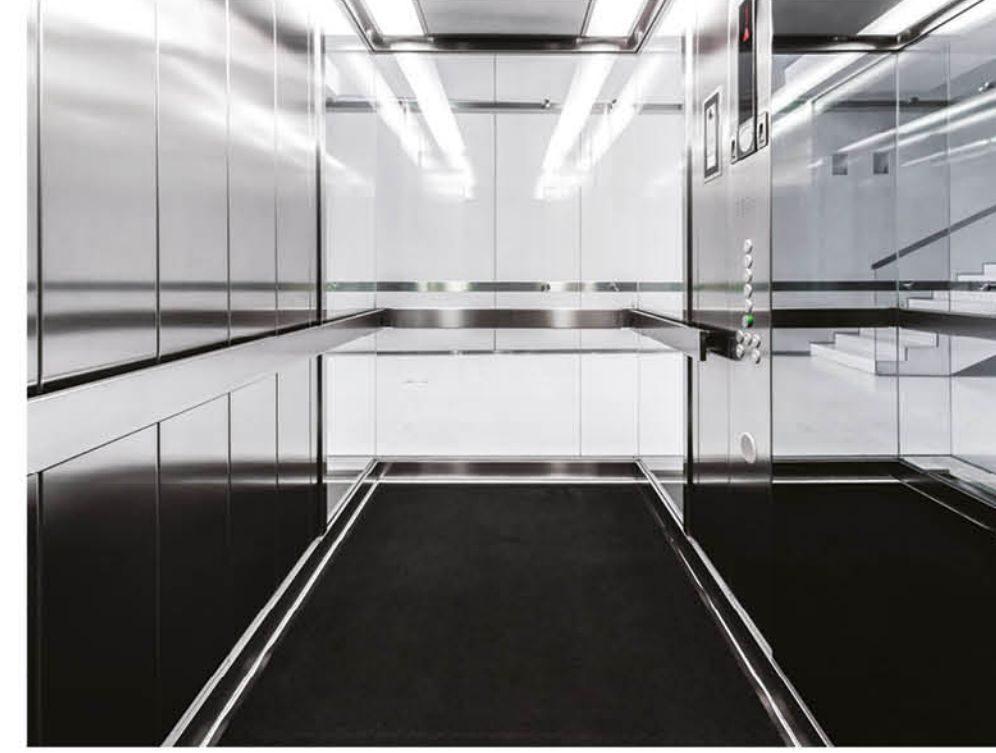



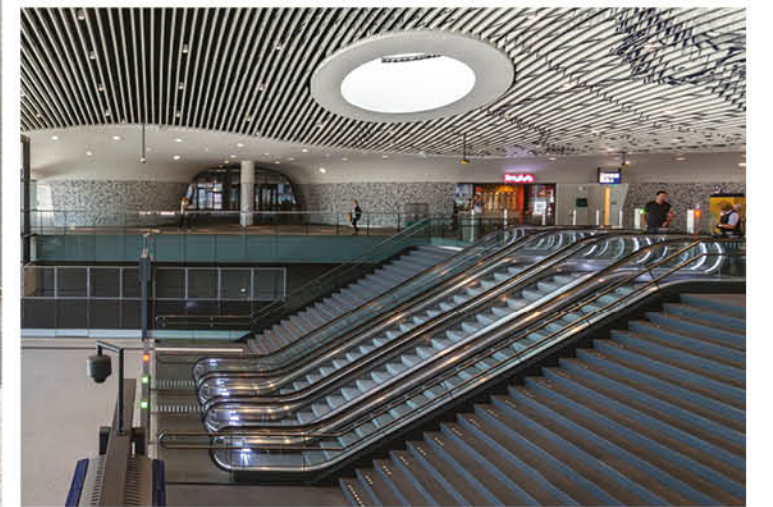
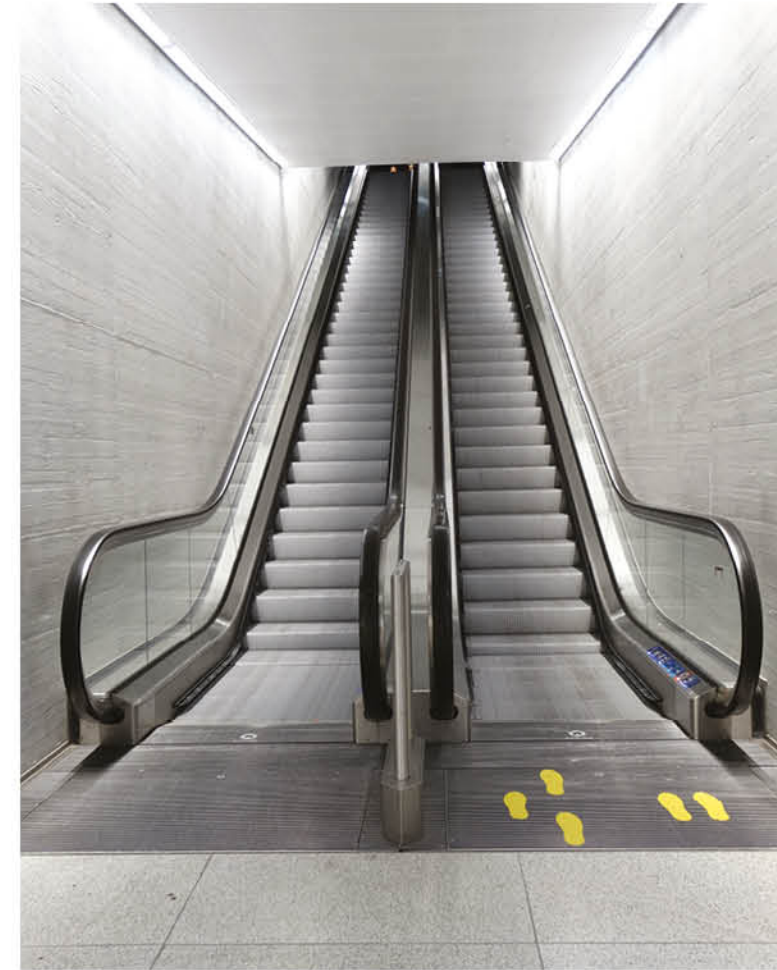

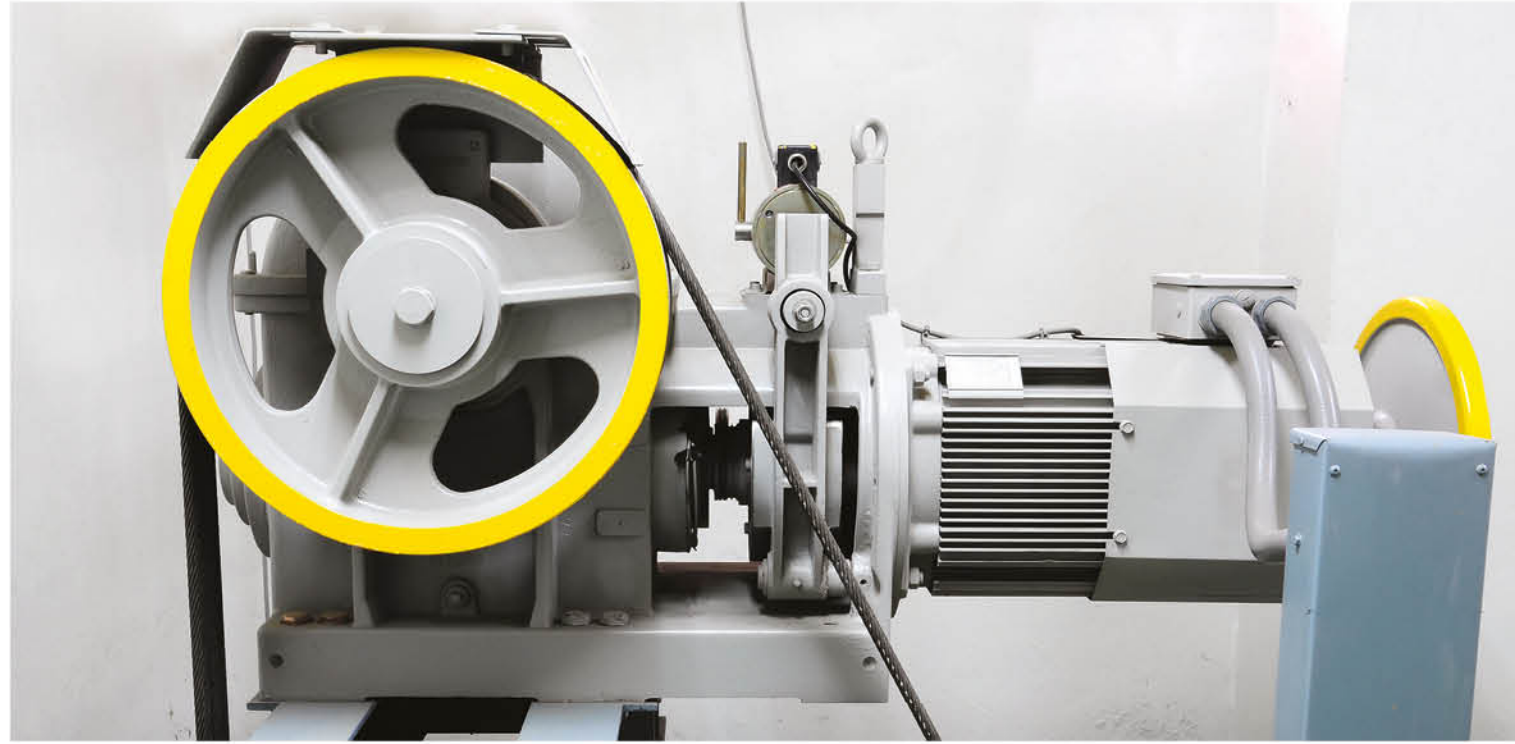

ALAMEX-T-ZF



ALAMEX-T-VOLPI



ALAMEX-T-MUGEN



ALAMEX-T-FORCE



ALAMEX-T-AK



ALAMEX-T-VOLPI



ALAMEX-T-S



ALAMEX-MEX-T-QUITE



ALAMEX-T-SMART



ALAMEX-T-STRONG LITE



ALAMEX-T-STRONG PLUS



ALAMEX-T-STRONG



MONTANARI MG V



LAFERT T24



ALBERTO SASSI G



SICOR SG



MONTANARI MR



TOPGEARS ITG



ALBERTO SASSI



SICOR MR



SICOR SGS



ZIEHL-ABEGG ZATOP



ALAMEX-QS-3



ALAMEX-QS-5



ALM-T-U21YT001



ALM-T-U20KU0002



ALM-T-U20KU0003



ALM-T-20KU0004



ALM-T-U20KU0001



ALM-T-U30KU0001



ALM-T
U27TM0001



ALM-T
U21TM0003



ALM-T
U21TM0006



ALM-T
U27YR0001



ALM-T
U21YR0005



ALM-TRN4110D



ALM-T-41B0



ALM-T
RN1012



ALM-T
RN1072



ALM-T
1082



ALM-T
1072



ALM-T
1012



ALM-T-73-CDD



ALM-T-733-CDD



ALM-T-732-MEGA7V-DM



ALM-T-931-MEGA7V-DM



ALM-T-932-MEGA7V-DM



ALM-T-932-CDD



ALM-T
U20SM0016



ALM-T
U20SM0009



ALM-T
U20SM0010



ALM-T
U20SM0005



ALM-T
U26SM0002



ALM-T
U20SM0014



ALM-T
U26DB0001



ALM-T
U20DB0001



ALM-T
U20DB0004



ALM-T
U20DB0002



ALM-T
U20DB0005



ALM-110

ALM-120

ALM-130

ALM-140

ALM-150



ALM-160

ALM-170

ALM-180

ALM-190

ALM-200



ALM-210

ALM-220

ALM-230

ALM-240

ALM-250



Özellikler

- 1,2 mm DKP sac üstüne 0,8 mm paslanmaz giydirmeler
- Ses ve titreşime karşı desteklenmiştir.
- Uluslararası standartlara uygun imal edilmektedir.
- Engel tanıma özellikli kart
- Elektronik 24V trafo
- Fotosel ve yangın ikaz girişleri
- 24V fırçasız motor
- Düşük hızda yüksek tork
- Yüksek hızda yüksek konfor
- İsteğe bağlı amiyant döşeme paneller

Merkezi Kapı
Central Door

Teleskopik Kapı
Telescopic Door



Features

- 0,8mm stainless panes on 1,2mm DKP sheets
- Supported structure against vibration and noise
- Made according to international standards
- Control card recognising obstacle
- Electronic 24v power supply
- Photocell and fire alarm inputs
- 24v brushless motor
- Low speed high torque
- High comfort at high speed
- Optional fire resistant flooring panels



2 panel teleskopik kabin kapı mekanizması
2 Panel Telescopic Cabin Door Mechanism



2 panel teleskopik kabin kapı mekanizması
2 Panel Telescopic Cabin Door Mechanism



2 Panel Teleskopik Kabin Kapı Mekanizması
2 Panels Central Cabin Door Mechanism



2 Panel Merkezi Kat Kapı Mekanizması
2 Panels Central Cabin Door Mechanism



2 Panel Teleskopik Kat Kapı Mekanizması
2 Panels Telescopic Landing Door Mechanism



3 panel teleskopik kabin kapı mekanizması
3 Panel Telescopic Cabin Door Mechanism



2 panel teleskopik kabin kapı mekanizması
2 Panel Telescopic Cabin Door Mechanism



2 Panel Teleskopik Kat Kapı Mekanizması
2 Panels Telescopic Landing Door Mechanism

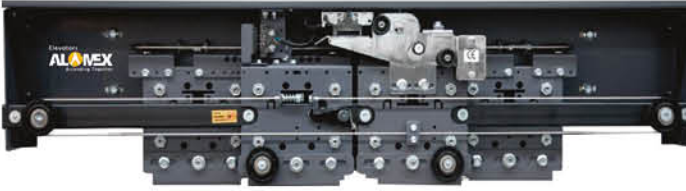

4 Panel Merkezi Kat Kapı Mekanizması
4 Panels Central Cabin Door Mechanism



2 Panel Merkezi Kat Kapı Mekanizması
2 Panels Central Cabin Door Mechanism



2 panel teleskopik kabin kapı mekanizması
2 Panel Telescopic Cabin Door Mechanism



2 Panel Merkezi Kat Kapı Mekanizması
2 Panels Central Cabin Door Mechanism

Genel Özellikler

Kolay montaj
Panellerin üç eksende ayarı
Giriş genişlik ayarı
Yüksek çalışma performansı
220 V AC besleme gerilimi
24V DC redüktörlü motor
Çift kanal 100 puls enkoder
Satandart HDC-24 sürücü ile
Limit switch'siz çalışma
LCD ekran ile kolay parametre ayarı
Tanıtma işlemi ile boyut algılama
Ayarlanabilir baskı kuvveti

General Features

Easy installation
Panel adjustment in three axes
Entry width adjustment
High operation performance
220V AC supply voltage
24V DC with reductor motor
100 pulse dual channel encoder
With standard HDC-24 driver
Operation without limit switch
Easy parameter setting with LCD display
Size detection with the introduction process.
Adjustable pressure force



3 panel teleskopik kabin kapı mekanizması
3 Panel Telescopic Cabin Door Mechanism



4 Panel Merkezi Kat Kapı Mekanizması
4 Panels Central Cabin Door Mechanism



2 Panel Teleskopik Kat Kapısı
2 Panels Telescopic Landing Door



2 Panel Teleskopik Bakır Kat Kapısı
2 Panels Telescopic Landing Door



ALM-T-DS-01



ALM-T-DS-02

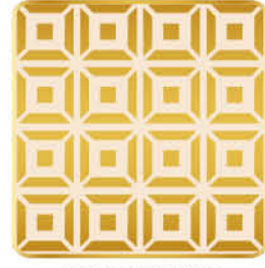

ALM-T-DS-03



ALM-T-DS-04



ALM-T-DS-05



ALM-T-DS-06

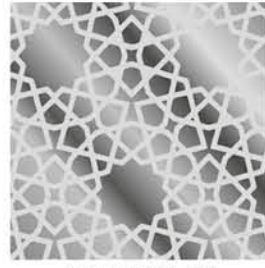

ALM-T-DS-07



ALM-T-DS-08

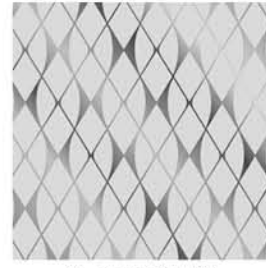

ALM-T-DS-09



ALM-T-DS-10

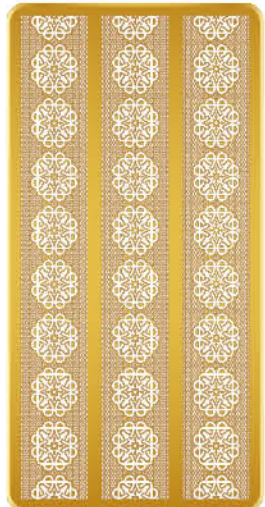

ALM-T-DS-11



ALM-T-DS-12



ALM-T-DS-13

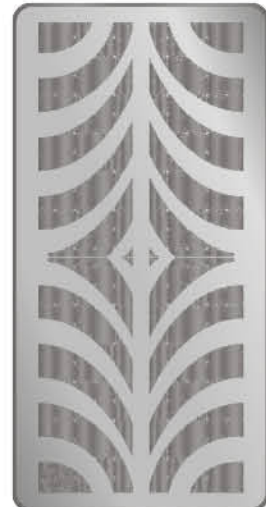

ALM-T-DS-14



ALM-T-DS-15

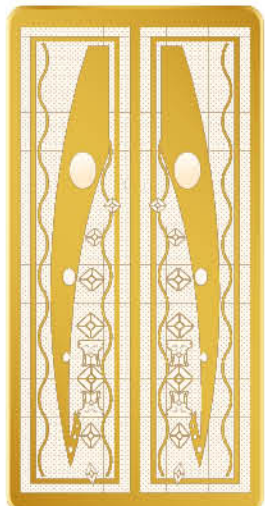

ALM-T-DS-16



ALM-T-DS-17



ALM-T-DS-18



ALM-T-DS-19



ALM-T-DS-20



Ağırlık Şasesi Dişsiz
Counter Weight Chasis Gearless

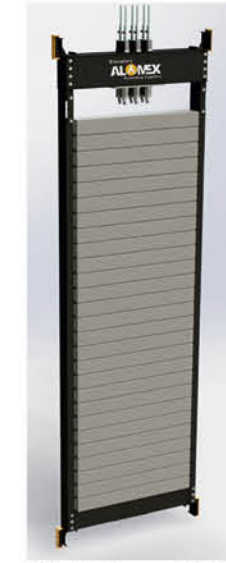

Ağırlık Şasesi Dişli
Counter Weight Chasis Geared



Süspansiyon Dişli
Car sling geared



Süspansiyon Dişsiz
Car sling gearless



L-Karkas
L-Elevator Frame



Dişsiz Makina Sehbası
Gearless Machine Stand

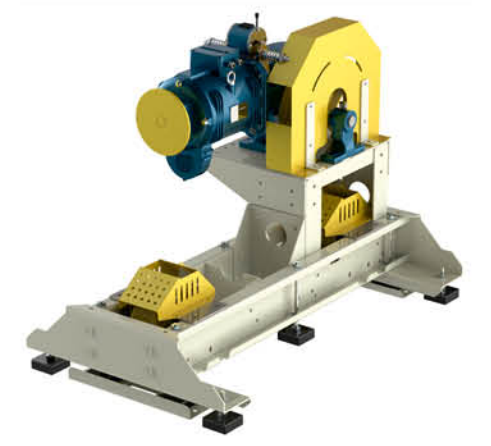

Dişli Makina Sehbası
Geared Machine Table



Kuyu Dipsiz L Karkas
L Frame Without Pit



Hidrolik L Karkas
L Frame for Hydraulic Lifts



Makina Sehbası
Machine Stand

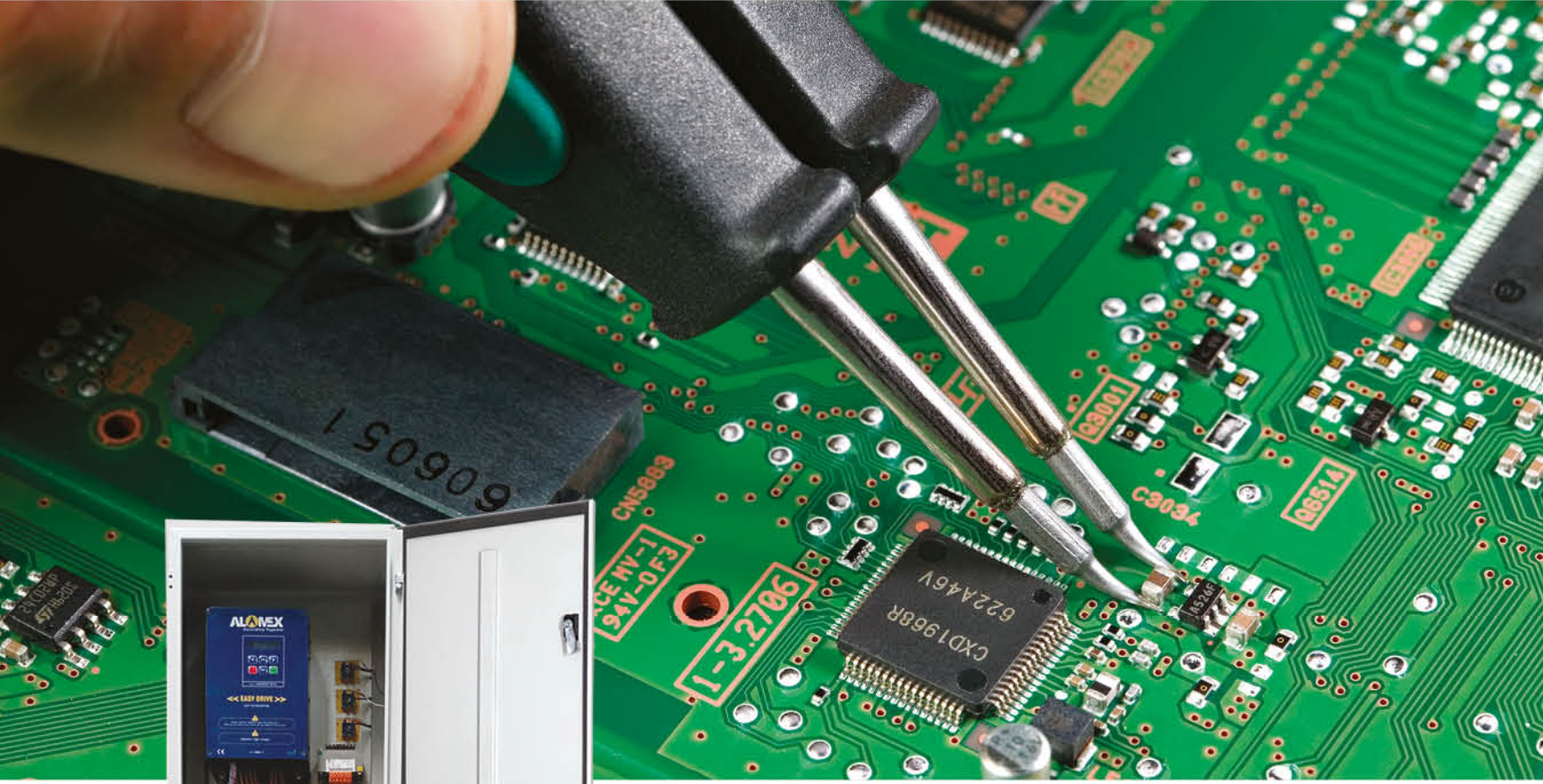

Dişlisiz Pano
Gearless Control Panel

Dişlilili Pano
Geared Control Panel

Asansör Kumanda Panosu
Elevator Control Panel



EN 81-20
Yönetmeliğine Uygundur
Conform to
EN 81-20 Regulation



KOMPLE HAZIR TESİSAT SİSTEMİ **COMPLEX READY INSTALLATION SYSTEM**

- Kumanda Panosu
- Dişlilili/Dişlisiz Tahrik Makinası
- Hız Regülatörü
- Acil Stop Butonu
- Acil Kurtarma Kapısı Konağı
- 3 Faz Ana Besleme
- Paraşüt Fren
- Revizyon Kutusu
- Alt ve Üst Tekereklili Sınır Şalterleri
- Güvenlik Sönsürö
- Alt ve Üst Sınır Şalterleri
- Kabin Lambası
- Kabin Fani
- Kabin ve Kabin Kapısı
- Kabin Butonu
- Boy Fotosel
- Fiş/Kilit/Toprak Bağlantı Soketleri
- Kat Kapıları
- Kat Kasetleri
- Kabin/Karşı Ağırlık Tamponu Konağı
- Hız Regülatörü Halat Gergi Konağı
- Kuyu Dibi Panosu
- Kuyu Dibi El Kumanda Butonu
- İntercom Telefonu

- Lift Control Panel
- Geared/Gearless Traction Machine
- Overspeed Governor
- Emergency Stop Button
- Emergency Trap Door Contact
- 3 Phase Main Power Supply
- Safety Gear
- Inspection Box
- Bottom and Top Whell Type Limit Switches
- Safety Sensor
- Bottom and Top Limit Switches
- Cabin Light
- Cabin Fan
- Cabin and Cabin Door
- Cabin Operating Panel
- Light Curtain
- Door/Lock/Earth Connection Sockets
- Landing Doors
- Landing Operating Panels
- Cabin/Counterweight Buffer Contact
- Ov. Governor Tension Pulley Contact
- Pit Connection Box
- Pit Manual Control Unit
- Intercom Phone

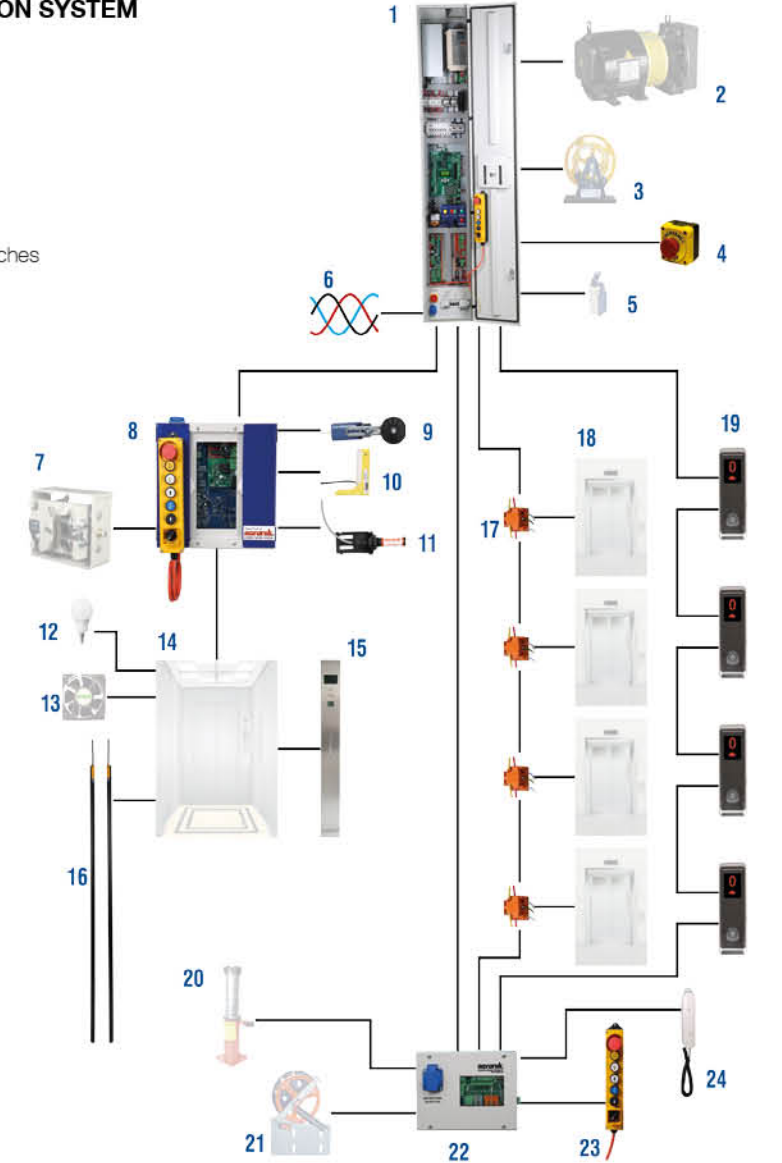

Dişlisiz Pano
Gearless Control Panel

Teknik Özellikler:

- Durak Sayısı: 16
- Tesiisat: Kabin ve kat butonyerleri ile seri veya paralel bağlantı imkanı ve Arcode uyumlu seri tesiisat birimleri
- Kapı Köprüleme: Mevout
- Kumada Tipi: Tek Buton Toplama, Çift Buton Toplama
- Asansör Hızı: 1.75 m/s
- Standart Uygunluk: EN 81-20
- Tahrik Tipi: Elektrikli
- Kabin Pozisyon Bilgisi: Manyetik Şalter ya da motor enkoderi
- Modeller: 4kW(10A)-5.5kW(14A)-7.5kW(17A)-11kW(26A)
- Grup Kumanda: Dupleks
- Motor Sürme Tipi: STO fonksiyonlu kontaktörsüz sürüş
- Kalkış Tutma: Ön-tork ve kalkış tutma fonksiyonları ile kalkışta geri kaymayı önleme

Features

- Number of Stoops : 16
- Cabling: Serial or parallel connection options with Lop's and COP's Arcode compatible serial communication unit
- Door Bridging: Available
- Control Type: Single button collective, Double button collective
- Elevator Speed: 1.75 m/s
- Compliance to Standards: EN 81-20
- Drive Type: Traction
- Car Positioning: Magnetic switches or motor encoder
- Models: 4kW(10A)-5.5kW(14A)-7.5kW(17A)-11kW(26A)
- Group Control: Duplex
- Motor Drive Type: Contactless drive with STO function
- Rollback Prevention: Rollback prevention at start through pre-torque and anti-rollback functions

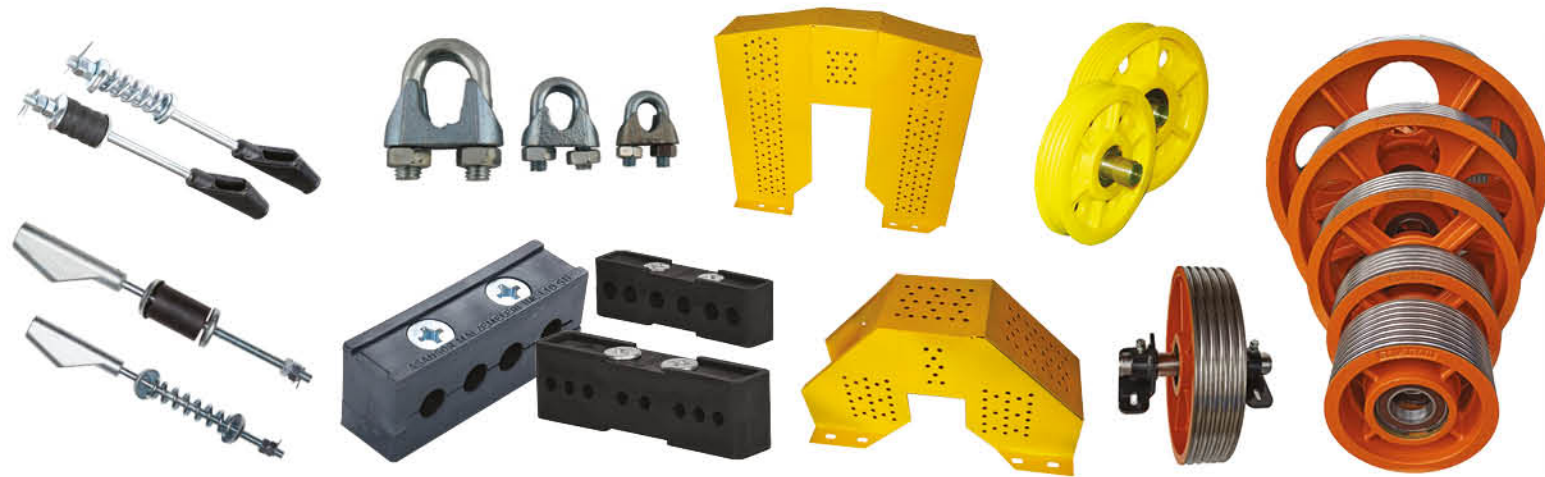
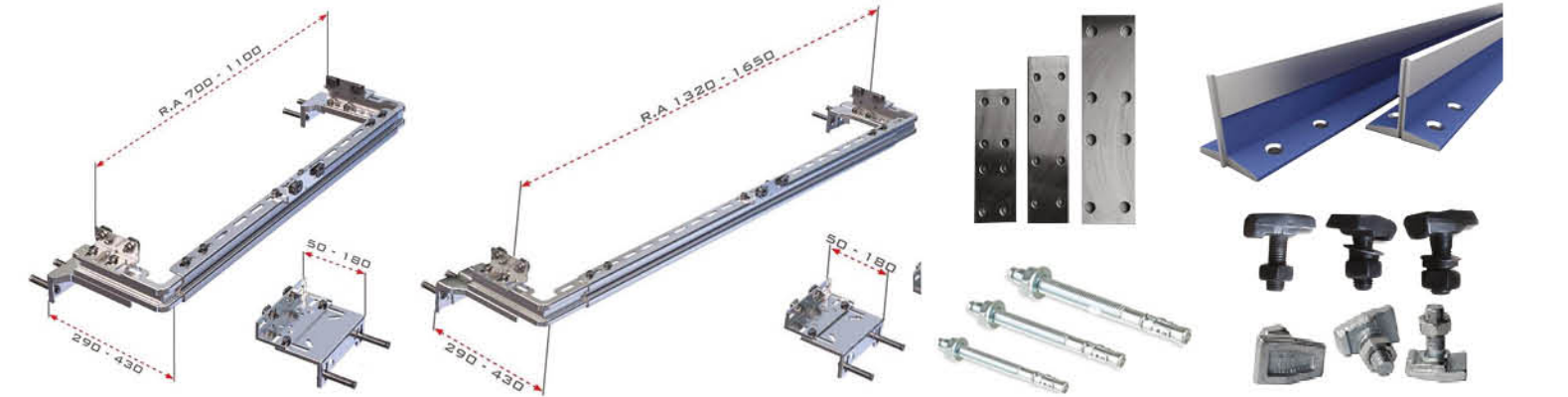

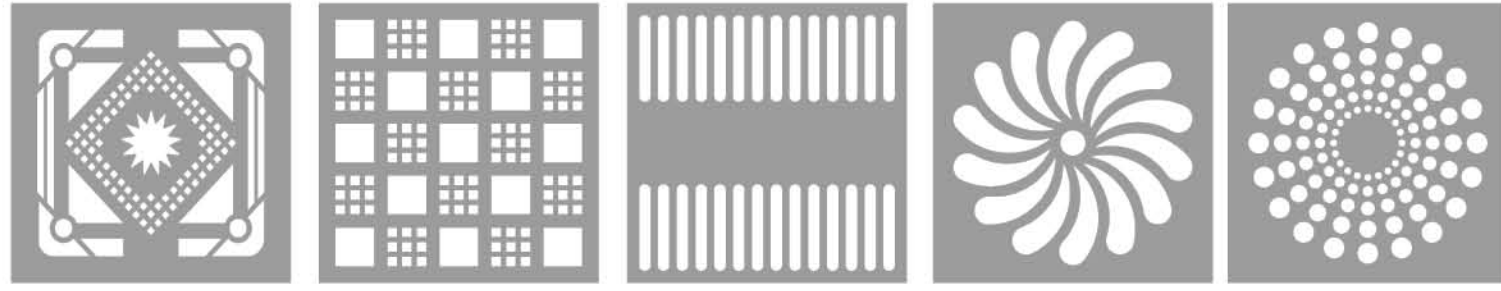

ALM-T-01

ALM-T-02

ALM-T-03

ALM-T-04

ALM-T-05



ALM-T-06

ALM-T-07

ALM-T-08

ALM-T-09

ALM-T-10

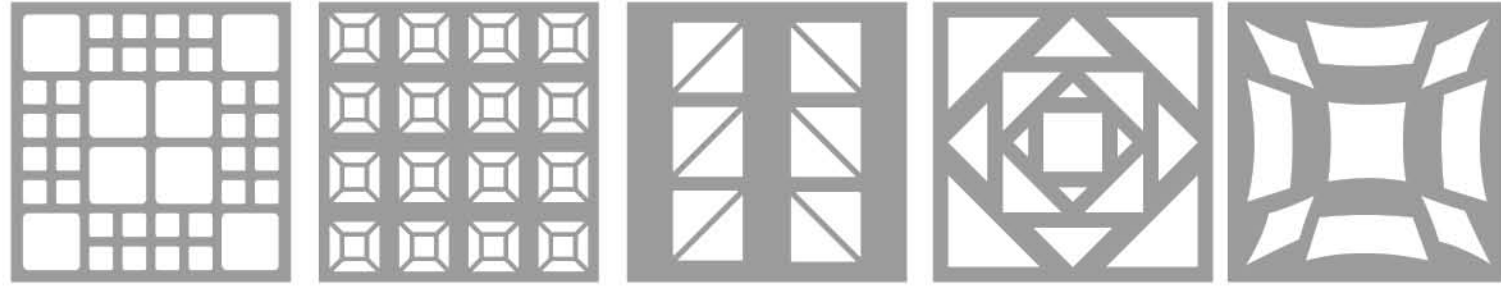

ALM-T-11

ALM-T-12

ALM-T-13

ALM-T-14

ALM-T-15



ALM-T-16

ALM-T-17

ALM-T-18

ALM-T-19

ALM-T-20

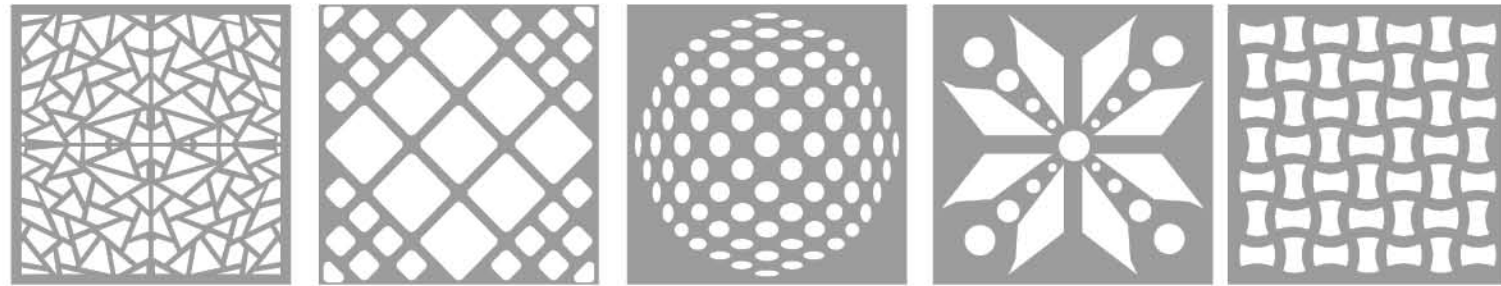

ALM-T-21

ALM-T-22

ALM-T-23

ALM-T-24

ALM-T-25

Granit ve PVC Taban Seçenekleri | Granite & PVC Floor Options

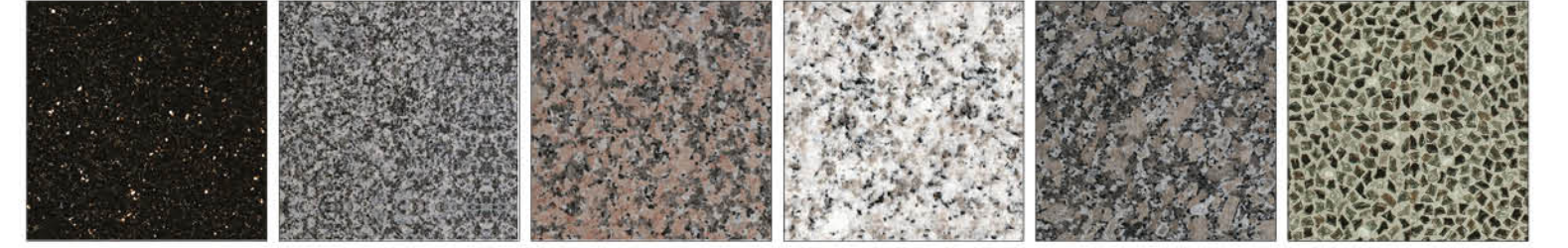

Star Galaxy

Yerli Koyu Granit

Rosa Porino

Bianco Perla

Rosa Minho

PVC 3717



PVC ES-5

PVC AEZ-154

PVC AEZ-149

PVC AEZ-148

PVC AEZ-156

PVC AEZ-151

Temperli Cam (Lamineli) Seçenekleri | Tempered Glass (Laminated) Floor Options



ACT-01

ACT-02

ACT-03

ACT-04

ACT-05

ACT-06

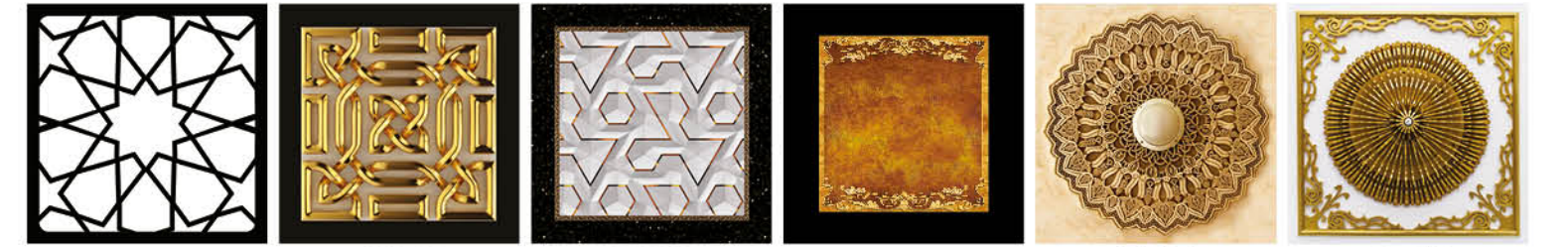

ACT-10

ACT-11

ACT-12

ACT-13

ACT-14

ACT-15

Özel Seramik Taban Seçenekleri | Special Ceramic Floor Options



Bakü Altın

Basra Altın

Casablanca Altın

Lusaka Altın

YD-23



G-3026



G-3027



G-3028



G-3029



G-3030



G-3041



G-3042



G-3043



G-3044



G-3045



G-3031



G-3032



G-3033



G-3034



G-3035



G-3046

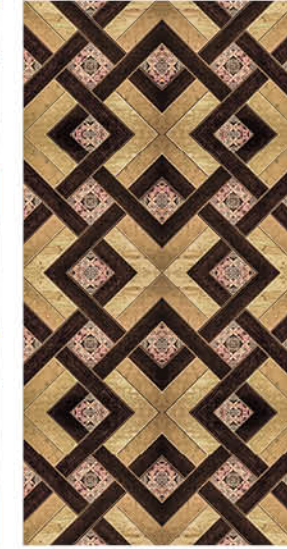

G-3047

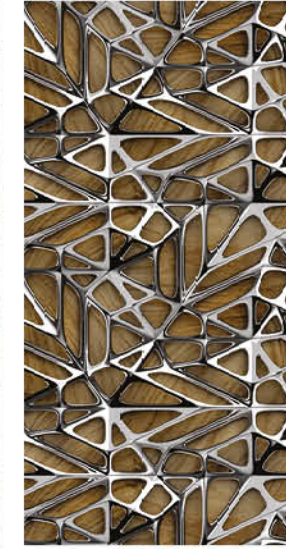

G-310

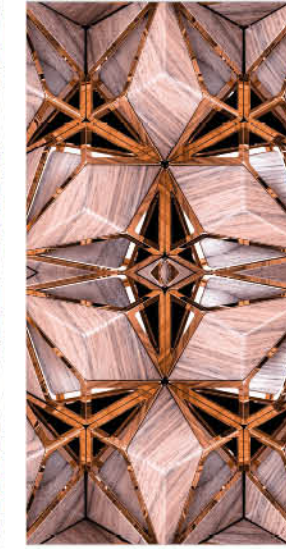

G-3048



G-3048



G-3036



G-3037



G-3038



G-3029



G-3040



G-3049



G-3050



G-3051



G-3052



G-3053

İnsan Asansörleri (Sınıf I-II) Fonksiyonel Boyutlar / Passenger Elevators (Class I-II) Functional Dimensions

				KONUTLAR / HOUSES				İŞYERLERİ / OFFICES					
TAŞIMA KAPASİTESİ / CAPACITY				(Kg)	320	400	630	1000	630	800	1000	1250	1600
ANMA YÜKÜ / NOMINAL LOAD				(Kişi)	4	5	8	13	8	10	13	16	21
KABİN ALANI / CABIN SPACE				(min)	0,79	0,98	1,45	2,15	1,45	1,73	2,15	2,57	3,245
				(max)	0,95	1,17	1,66	2,40	1,66	2,00	2,40	2,90	3,56
KABİN EBATLARI CABIN DIMENSIONS	Genişlik / Width	b1	(mm)	900	1100	1100	1100	1100	1350	1600	1950	1950	
	Derinlik / Depth	d1	(mm)	1000	1000	1400	2100	1400	1400	1400	1400	1750	
	Yükseklik / Height		(mm)	2200	2200	2200	2200	2200	2200	2300	2300	2300	
DURAK KAPILARI LANDING DOORS	Genişlik	b2	(mm)	700	800	800	800	800	800	1100	1100	1100	
	Yükseklik	h3	(mm)	2000	2000	2000	2000	2000	2000	2100	2100	2100	
KUYU EBATLARI SHAFT DIMENSIONS	Genişlik 1)	b3	(mm)	1400	1600	1600	1600						
	Genişlik 2)	b3	(mm)		1800	1800	1800	1800	1900	2400	2600	2600	
	Derinlik	d2	(mm)	1600	1600	1900	2600	2100	2300	2300	2300	2600	
KUYU DİBİ DERİNLİĞİ PIT	0,63m/sn	d3	(mm)	1400	1400	1400	1400	1400	1400	1400	1600	1600	
	1,00m/sn	d3	(mm)	1400	1400	1400	1400	1400	1400	1400	1600	1600	
	1,60m/sn	d3	(mm)		1600	1600	1600	1600	1600	1600	1600	1600	
	2,50m/sn	d3	(mm)			2200	2200		2200	2200	2200	2200	
EN ÜST DURAK SEVİYESİ ÜSTÜNDEKİ YÜKSEKLİK OVERHEAD	0,63m/sn	h1	(mm)	3600	3600	3600	3600	3800	3800	4200	4400	4400	
	1,00m/sn	h1	(mm)	3700	3700	3700	3700	3800	3800	4200	4400	4400	
	1,60m/sn	h1	(mm)	3800	3800	3800	3800	4000	4000	4200	4400	4400	
	2,50m/sn	h1	(mm)			5000	5000		5000	5200	5400	5400	
M A K İ N A D E R İ N L İ K A İ R O M S İ	ALAN SPACE	0,63m/sn	A	(m2)	6	7,5	10	12	15	15	20	22	25
		1,00m/sn	A	(m2)	6	7,5	10	12	15	15	20	22	25
		1,60m/sn	A	(m2)		10	12	14	15	15	20	22	25
		2,50m/sn	A	(m2)			14	16		18	20	22	25
	GENİŞLİK WIDTH	0,63m/sn	h1	(mm)	1600	2200	2200	2400	2500	2500	3200	3200	3200
		1,00m/sn	h1	(mm)	1600	2200	2200	2400	2500	2500	3200	3200	3200
		1,60m/sn	h1	(mm)		2200	2200	2400	2500	2500	3200	3200	3200
		2,50m/sn	h1	(mm)			2800	2800		2800	3200	3200	3200
	DERİNLİK DEPTH	0,63m/sn	d4	(mm)	3000	3200	3700	4200	3700	3700	4900	4900	5500
		1,00m/sn	d4	(mm)	3000	3200	3700	4200	3700	3700	4900	4900	5500
		1,60m/sn	d4	(mm)		3200	3700	4200	3700	3700	4900	4900	5500
		2,50m/sn	d4	(mm)			3700	4200		3700	4900	4900	5500
YÜKSEKLİK HEIGHT	0,63m/sn	h2	(mm)	2000	2000	2000	2000	2200	2200	2400	2400	2800	
	1,00m/sn	h2	(mm)	2000	2000	2000	2000	2200	2200	2400	2400	2800	
	1,60m/sn	h2	(mm)		2200	2200	2200	2200	2200	2400	2400	2800	
	2,50m/sn	h2	(mm)			2600	2600		2800	2800	2800	2800	

*Sağa veya sola toplanan teleskopik kapılı asansörler için / For telescopic elevators with doors opening to the right and left

**Merkezden açılan kapılı asansörler için / For elevators with central opening

***320 ve 400 Kg. taşıma kapasiteli asansörler engelli kişilerin tekerlekli sandalyede asansörü kullanmaları için uygun değildir / Elevators with a load capacity of 320 and 400 kg are not suitable for use by people with disabilities in a wheelchair

Hasta Asansörleri (sınıf I-II) Fonksiyonel Boyutlar / Patient Lifts (class I-II) Functional Dimensions

TAŞIMA KAPASİTESİ / Capacity			(Kg)	1600	2000	2500
KABİN ALANI / Cabin space			(min)	3,245	3,82	4,625
			(max)	3,56	4,2	5
KABİN EBATLARI Cabinet Dimensions	Genişlik / Width	b1	(mm)	1400	1500	1800
	Derinlik / Depth	d1	(mm)	2400	2700	2700
	Yükseklik / Height		(mm)	2300	2300	2300
DURAK KAPILARI Stall Doors	Genişlik / Width	b2	(mm)	1300	1300	1300
	Yükseklik / Height	h3	(mm)	2100	2100	2100
KUYU EBATLARI Pit dimensions	Genişlik / Width	b3	(mm)	2400	2400	2700
	Derinlik / Depth	d2	(mm)	3000	3200	3300
KUYU DİBİ DERİNLİĞİ Elevator Pit Bottom	Vn=0,63m/sn	d3	(mm)	1600	1600	1800
	Vn=1,00m/sn	d3	(mm)	1700	1700	1900
	Vn=1,60m/sn	d3	(mm)	1900	1900	2100
	Vn=2,50m/sn	d3	(mm)	2500	2500	2500
EN ÜST DURAK SEVİYESİ ÜSTÜNDEKİ YÜKSEKLİK Height Above the Highest Stall Level	Vn=0,63m/sn	h1	(mm)	4400	4400	4400
	Vn=1,00m/sn	h1	(mm)	4400	4400	4600
	Vn=1,60m/sn	h1	(mm)	4400	4400	4600
	Vn=2,50m/sn	h1	(mm)	5400	5400	5600
MAKİNA DAİRESİ Engine Room	ALAN / Space	A	(m2)	25	27	29
	GENİŞLİK / Width	b4	(mm)	3200	3200	3500
	DERİNLİK / Depth	d4	(mm)	5500	5800	5800
	YÜKSEKLİK / Height	h2	(mm)	2800	2800	2800

Yük Asansörleri (sınıf IV) Fonksiyonel Boyutlar / Load Elevators (Class IV) Functional Dimensions

TAŞIMA KAPASİTESİ / Carriage Quality			(Kg)	630	1000	1600	2000
KABİN EBATLARI Cabinet Dimensions	Genişlik / Width	b1	(mm)	1100	1300	1500	1500
	Derinlik / Depth	d1	(mm)	1400	1750	2250	2700
	Yükseklik / Height		(mm)	2200	2300	2200	2200
DURAK KAPILARI Stall Doors	Derinlik / Depth	b2	(mm)	1100	1300	1500	1500
	Yükseklik / Height	h3	(mm)	2100	2100	2100	2100
KUYU EBATLARI Pit Dimensions	Genişlik / Width	b3	(mm)	2100	2400	2700	2700
	Derinlik / Depth	d2	(mm)	1900	2300	2800	3200
KUYU DİBİ DERİNLİĞİ Elevator Pit Bottom	V<1,00m/sn	d3	(mm)	1500	1500	1700	1700
EN ÜST DURAK SEVİYESİ ÜSTÜNDEKİ YÜKSEKLİK Height Above the Highest Stall Level	V<1,00m/sn	h1	(mm)	4100	4100	4300	4300
MAKİNA DAİRESİ Engine Room	ALAN / Space	A	(mm)	12	14	18	20
	GENİŞLİK / Width	b4	(mm)	2800	3100	3400	3400
	DERİNLİK / Depth	d4	(mm)	3500	3800	4500	4900
	YÜKSEKLİK / Height	h2	(mm)	2200	2200	2400	2400

Servis Asansörleri (sınıf V) Fonksiyonel Boyutlar / Service Elevators (Class V) Functional Dimensions

TAŞIMA KAPASİTESİ / Carriage Quality			(Kg)	40	100	250
KABİN EBATLARI Cabinet Dimensions	Genişlik / Width	b1	(mm)	600	800	1000
	Derinlik / Depth	d1	(mm)	600	850	1000
	Yükseklik / Height		(mm)	800	800	1200
KUYU EBATLARI Pit Dimensions	Genişlik / Width	b3	(mm)	900	1100	1500
	Derinlik / Depth	d2	(mm)	800	1000	1200

Yükselen Yapıların Tercihii!

Rising Structures Preference!

Elevators

ALAMEX[®]
Ascending Together

ALAM ASANSÖR SANAYİ TİCARET LİMİTED ŞİRKETİ

Fevziçakmak Mah. İmsan Sanayi Sitesi Gülistan Cad. No: 40/A
Karatay / KONYA / TÜRKİYE

Tel: +90 (332) 503 15 08 | info@alamex.com.tr | www.alamex.com.tr